



# MOCAP®

Manufacturer of Quality Rubber and Plastic Products

# MOCAP<sup>®</sup>

Originated in St. Louis, Missouri in 1982

## Manufacturer of Quality Plastic & Rubber Products

MOCAP Park Hills, MO

MOCAP Farmington, MO



MOCAP Park Hills, MO



Park Hills, Missouri • USA



MOCAP Farmington, MO



Farmington, Missouri • USA

**MOCAP** has steadily grown from a small dip moulding operation into several divisions with multiple facilities totalling more than 25,000 square metres. Our manufacturing capabilities include Vinyl Dip Moulding, Plastic & Rubber Injection Moulding, Clear Plastic & Rubber Extrusion and Blow Moulding.

**MOCAP** has sales offices in the United States, United Kingdom, China and Mexico serving thousands of customers globally with our Product Protection, Masking, Finishing and Packaging products.

**[www.mocap.co.uk](http://www.mocap.co.uk) 0800 856 2466 [sales@mocap.co.uk](mailto:sales@mocap.co.uk)**  
**Hortonwood 35, Telford, Shropshire TF1 7YW, Great Britain**



Sheffield, England • UK



MOCAP Sheffield, England • UK

MOCAP Telford, England • UK



Telford, England • UK



MOCAP Zhongshan,  
Guangdong Province,  
People's Republic of China



Zhongshan, Guangdong Province  
People's Republic of China

**MOCAP** Manufacturer of Quality Plastic & Rubber Products

**International Sales:**



*please see the back cover for contact information*



**MOCAP** Stocked Parts

*We keep many varieties of our caps, plugs and grips in stock and ready to ship. All of our stock items are available in Box, Mini-Pack and Micro-Pack quantities and can be ordered online for faster turnaround.*

[www.mocap.co.uk](http://www.mocap.co.uk)

# Contents

## 1. Friction Fit Caps & Plugs



*Non-Threaded Design Allows for Easy Placement and Removal to Protect Threads and Fittings*

## 22. Tapered Caps & Plugs



*Designed with Slight Taper to Secure Tightly to Protect Threads and Fittings*

## 30. Threaded Caps & Plugs



*Designed to Fit a Variety of Standard and Metric Threads, Threaded Ports, Fittings and Assemblies*

## 41. Grips



*Round, Flat and Finger Nub Styles for Improved Appearance, Durability and Comfort*

## 45. Pipe & Flange Protection



*Caps, Plugs and Push-In Flange Protectors for Use with Pipe, Tubing and Flanges*

## 49. Masking



*Caps, Plugs, Tapes and Discs in a Variety of Materials, Shapes, Sizes and Temperature Requirements*

## 62. Mesh Netting

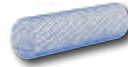

*Mesh Plastic Netting for Superior Protection*

## 62. Secondary Operations



*Printing, Assembly, Packaging, Punching and Slicing, Customised to Fit Your Specifications*

### MICRO-PACKS & MINI-PACKS

**MOCAP** now offers Micro-Pack and Mini-Pack quantities when less than box quantities are what you really need. For more information about **MOCAP** products, please contact our sales team at 0800 856 466

### TERMS & CONDITIONS OF SALE

**Terms:** Net 30 Days from shipment, subject to credit approval. EXW our plant.

**Returns:** All returns or charge-backs must be authorised by **MOCAP**. Unauthorised returns cannot be accepted. Production run parts are not returnable, unless defective. Stock parts are subject to £30/40€ restocking charge. All claims for returns must be made within 30 days from invoice date.

**Samples:** **MOCAP** recommends approval of samples before ordering, especially on production run parts. An Application Advisor is available on our website as a guideline. Please request FREE Samples to test within your application. Returns will not be accepted if samples were refused.

For a complete list of terms and conditions visit our web site at: [www.mocap.co.uk](http://www.mocap.co.uk)

For Temperature Info, Material Specifications, Colour Options and Tolerances, please see page 66.

[www.mocap.co.uk](http://www.mocap.co.uk) 0800 856 2466 [sales@mocap.co.uk](mailto:sales@mocap.co.uk)



Hortonwood 35  
Telford, Shropshire TF1 7YW  
Great Britain



© Copyright 2018, MOCAP, LLC. All Rights Reserved. All Trademarks and Service Marks are the Properties of their Respective Owners.

**MOCAP**  
[www.mocap.co.uk](http://www.mocap.co.uk)

# MOCAP<sup>®</sup>

## Solutions that Fit

Caps • Plugs • Grips  
Protection • Finishing • Masking

Many Sizes and Styles in Stock  
for Metric, SAE, BSP, JIC, NPT Threads & Fittings

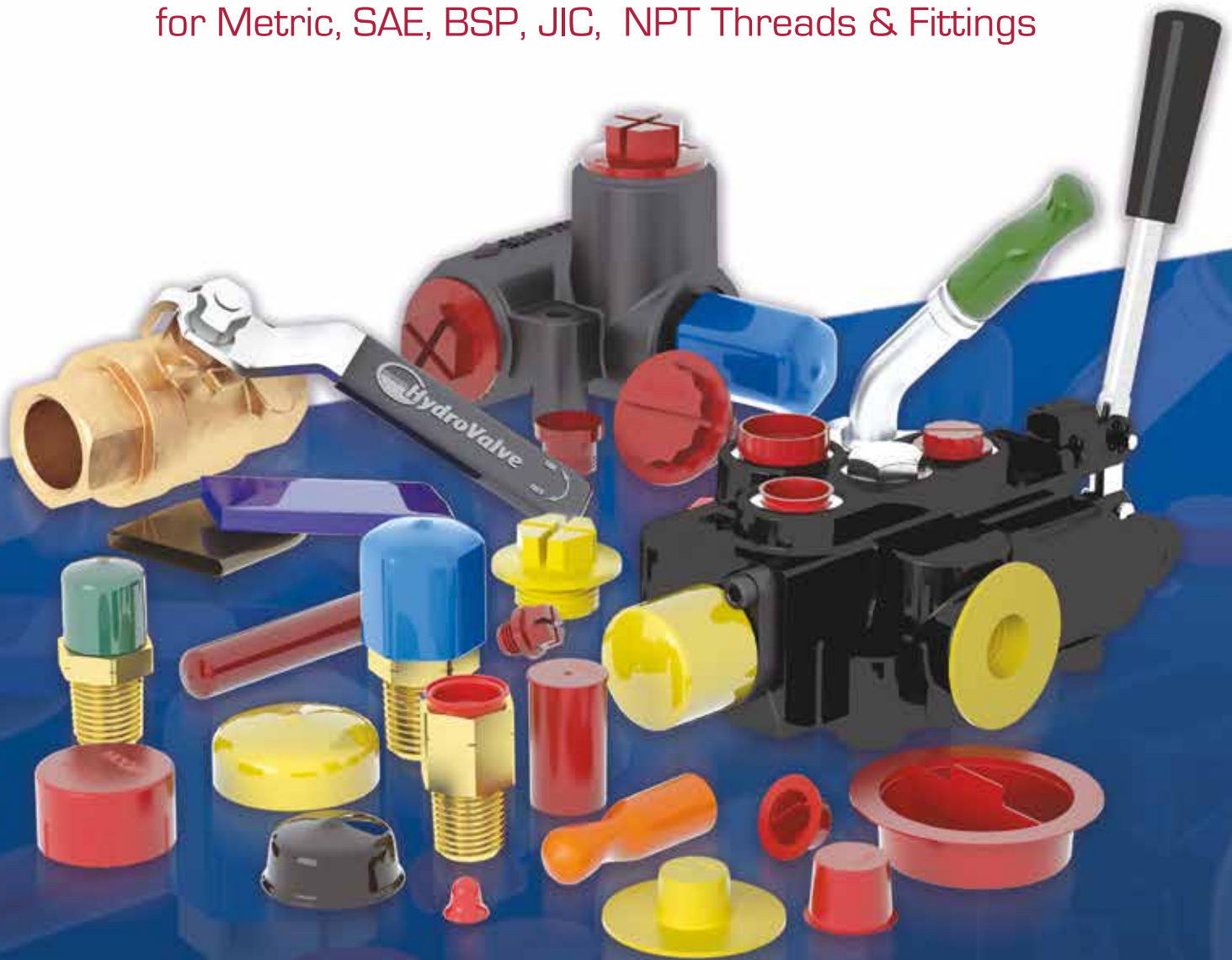

*Order Online For Fast Turnaround*

**MOCAP** **FREE**  
**SAMPLES**

**0800 856 2466**

[www.mocap.co.uk](http://www.mocap.co.uk)

[sales@mocap.co.uk](mailto:sales@mocap.co.uk)





# Friction Fit Caps & Plugs



## A Series Round Vinyl Caps

- Sizes to Fit Straight, Metric, BSP & NPT Threads and Fittings
- Use as Thread Protector or End Cap
- Flexible Yet Durable - Won't Split, Tear or Shred
- Printable
- Available in High-Temp Formula *refer to page 49*
- Material: Black Vinyl Additional Colours: ○●●●●●●●●●●



Part #	To Fit STD Thread	To Fit METRIC Thread	To Fit NPT	(A) Inside	(B) Min	(C) Max	(D) Wall	Stocked Length
				Diameter	Inside Length	Inside Length	Thickness	
				mm	mm	mm	mm	mm
A27.0S	1-1/16 12	M27	---	27.0	6.4	50.8	1.5	25.4 • 38.1
A28.6S	1-3/16 12	M30	---	28.6	6.4	50.8	1.5	25.4 • 38.1
A30.2S	1-3/16 12	---	---	30.2	6.4	50.8	1.5	25.4 • 38.1
A31.8S	1-5/16 12	M32	1	31.8	6.4	50.8	1.5	19.0 • 25.4 • 38.1
A33.4S	1-5/16 12	M35	1	33.4	6.4	38.1	1.5	38.1
A34.9S	1-7/16 12	M35 M36	---	34.9	6.4	50.8	1.5	38.1
A36.1S	---	M37	---	36.1	6.4	50.8	1.5	38.1
A37.2S	---	M38	---	37.2	6.4	50.8	1.5	38.1
A38.1S	1-5/8 12	M39 M40	---	38.1	6.4	50.8	1.5	38.1
A39.7S	1-11/16 12	---	1-1/4	39.7	6.4	50.8	1.5	38.1
A41.3S	1-11/16 12	M42	1-1/4	41.3	6.4	50.8	1.5	38.1
A42.0S	1-11/16 12	M42	1-1/4	42.0	6.4	50.8	1.5	38.1
A42.9S	1-11/16 12	---	1-1/4	42.9	6.4	50.8	1.5	25.4 • 38.1
A44.5S	---	M45	---	44.5	6.4	50.8	1.5	38.1
A47.6S	1-7/8 12	M48	1-1/2	47.6	6.4	50.8	1.5	38.1
A48.5S	---	---	---	48.5	6.4	50.8	1.5	--
A49.0S	---	M49 M50	---	49.0	6.4	50.8	1.5	38.1
A50.8S	2	M52	---	50.8	6.4	50.8	1.5	38.1
A52.7S	---	M53 M54	---	52.7	6.4	50.8	1.5	38.1
A54.0S	---	---	---	54.0	6.4	50.8	1.5	38.1
A55.0S	---	---	---	55.0	6.4	50.8	1.5	38.1
A57.2S	2-1/4 12	M58 M60	2	57.2	6.4	50.8	1.5	38.1
A60.3S	2-1/2 12	---	2	60.3	6.4	50.8	1.5	38.1
A63.5S	2-1/2 12	M64	---	63.5	6.4	50.8	1.5	25.4 • 38.1
A66.7S	---	M68	---	66.7	6.4	36.0	1.5	36.0
A69.9S	---	M72	2-1/2	69.9	6.4	50.8	1.5	38.1
A76.2S	---	M80	---	76.2	6.4	50.8	2.0	38.1
A77.0S	---	---	---	77.0	6.4	50.8	2.0	--
A80.0S	---	---	---	80.0	6.4	50.8	2.0	38.1
A82.6S	---	---	---	82.6	6.4	50.8	2.0	--
A89.0S	---	M90	3	89.0	6.4	45.0	2.0	38.1
A92.0S	---	---	---	92.0	6.4	50.8	2.0	38.1
A95.3S	---	---	---	95.3	6.4	50.8	2.0	--
A101.6S	---	M105	3-1/2	101.6	6.4	50.8	2.0	38.1
A114.3S	---	M115	4	114.3	6.4	50.8	2.0	--
A117.5S	---	M120	---	117.5	6.4	50.8	2.0	--
A120.0S	---	---	---	120.0	6.4	50.8	2.0	--
A127.5S	---	---	---	127.5	6.4	50.8	2.0	--
A152.0S	---	---	---	152.0	6.4	50.8	2.0	--
A162.0S	---	---	---	162.0	6.4	50.8	2.0	--
A200.0S	---	---	---	200.0	6.4	50.8	2.0	--
A214.0S	---	---	---	214.0	6.4	50.8	2.0	--

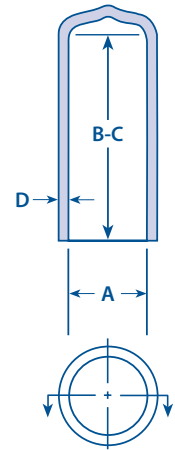

**High-Temp**  
Applications  
on pg. 49



0800 856 2466

# Friction Fit Caps & Plugs



## F Series

### Flat Vinyl Caps and Grips

- Caps Feature either a Round End or a Flat End
- Flexible Yet Durable - Won't Split, Tear or Shred
- Printable
- Material: Black Vinyl *Additional Colours:* ○○●●●●●●●●



Part #	(A) Inside Height mm	(B) Inside Width mm	(C) End Style	(D) Min Inside Length mm	(E) Max Inside Length mm	(F) Wall Thickness mm
F1.6S6.5	1.6	6.5	Flat	4.8	18.0	1.5
F1.6S7.3	1.6	7.3	Round	4.8	20.0	1.5
F1.6S8.0	1.6	8.0	Round	4.8	115.0	1.5
F1.6S9.5	1.6	9.5	Flat	4.8	101.6	1.5
F1.6S11.1	1.6	11.1	Round	4.8	101.6	1.5
F1.6S12.7	1.6	12.7	Flat	4.8	76.2	1.5
F1.6S15.9	1.6	15.9	Round	4.8	127.0	1.5
F1.6S19.0	1.6	19.0	Round	4.8	152.4	1.5
F1.6S21.0	1.6	21.0	Flat	4.8	38.1	1.5
F1.6S23.0	1.6	23.0	Flat	4.8	90.0	1.5
F1.6S36.5	1.6	36.5	Flat	4.8	152.4	1.5
F2.3S25.4	2.3	25.4	Flat	4.8	152.4	1.5
F3.0S18.0	3.0	18.0	Round	4.8	112.0	1.5
F3.0S32.0	3.0	32.0	Round	4.8	127.0	1.5
F3.0S38.0	3.0	38.0	Round	4.8	110.0	1.5
F3.0S50.8	3.0	50.8	Round	4.8	152.4	1.5
F3.0S70.0	3.0	70.0	Flat	4.8	110.0	1.5
F3.2S11.1	3.2	11.1	Round	4.8	76.2	1.5
F3.2S12.7	3.2	12.7	Round	4.8	152.4	1.5
F3.2S14.3	3.2	14.3	Flat	4.8	90.0	1.5
F3.2S15.9	3.2	15.9	Round	4.8	76.2	1.5
F3.2S19.0	3.2	19.0	Round	4.8	152.4	1.5
F3.2S22.2	3.2	22.2	Round	4.8	230.0	1.5
F3.2S25.4	3.2	25.4	Round	4.8	152.4	1.5
F3.2S26.9	3.2	26.9	Flat	4.8	152.4	1.5
F3.2S27.0	3.2	27.0	Round	4.8	152.4	1.5
F3.2S31.8	3.2	31.8	Round	4.8	60.5	1.5
F3.2S34.0	3.2	34.0	Flat	4.8	120.0	1.5
F3.3S34.0	3.3	34.0	Flat	4.8	152.4	1.5
F4.0S34.9	4.0	34.9	Round	4.8	152.4	1.5
F4.0S80.0	4.0	80.0	Flat	4.8	101.6	1.5
F4.0S100.0	4.0	100.0	Round	4.8	101.6	1.5
F4.8S35.0	4.8	35.0	Flat	4.8	127.0	1.5
F4.9S24.0	4.9	24.0	Flat	4.8	101.6	1.5
F5.0S21.0	5.0	21.0	Flat	4.8	152.4	1.5
F5.0S23.0	5.0	23.0	Flat	4.8	125.0	1.5
F5.0S25.0	5.0	25.0	Round	4.8	125.0	1.5
F5.0S45.0	5.0	45.0	Round	4.8	50.8	1.5
F5.0S58.0	5.0	58.0	Flat	4.8	30.0	1.5
F6.0S19.0	6.0	19.0	Round	4.8	152.4	1.5
F6.0S38.1	6.0	38.1	Round	4.8	152.4	1.5
F6.0S49.0	6.0	49.0	Round	4.8	160.0	1.5
F6.4S19.0	6.4	19.0	Round	4.8	50.8	1.5
F6.4S25.4	6.4	25.4	Round	4.8	152.4	1.5
F6.4S32.0	6.4	32.0	Flat	4.8	152.4	1.5
F6.4S38.1	6.4	38.1	Flat	4.8	125.0	1.5
F6.4S50.8	6.4	50.8	Flat	4.8	90.0	1.5
F8.0S20.0	8.0	20.0	Flat	4.8	70.0	1.5
F8.0S24.0	8.0	24.0	Flat	4.8	170.0	1.5
F8.0S25.0	8.0	25.0	Flat	4.8	110.0	1.5
F8.0S29.0	8.0	29.0	Flat	4.8	120.0	1.5
F8.0S38.1	8.0	38.1	Round	4.8	152.4	1.5
F10.0S29.0	10.0	29.0	Flat	4.8	152.4	1.5
F10.0S40.0	10.0	40.0	Flat	4.8	135.0	1.5
F12.7S63.5	12.7	63.5	Flat	4.8	80.0	1.5
F30.0S95.0	30.0	95.0	Flat	4.8	50.8	1.5

## Secondary Operations

Customised to Fit Your Specifications

Please Contact Sales for more information.



- Printing
- Punching & Slicing
- Assembly

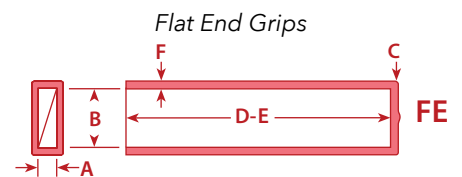
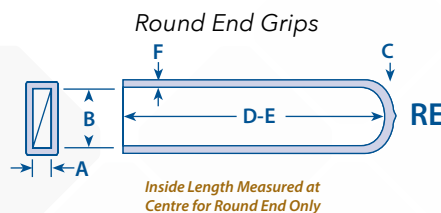

For More Information, Please Contact Sales on

**0800 856 2466**



# Friction Fit Caps & Plugs



## AS Series

### Square Vinyl Caps

- Stretches for a Snug Fit, but Won't Split, Tear or Shred
- Durable
- Material: Black Vinyl *Additional Colours:* ○●●●●●●●●●●



Part #	(A) Inside Width	(B) Min Inside Length	(C) Max Inside Length	(D) Wall Thickness
	mm	mm	mm	mm
AS10.7S	10.7	6.4	12.7	1.5
AS12.7S	12.7	6.4	150.0	1.5
AS15.6S	15.6	6.4	40.0	1.5
AS19.0S	19.0	6.4	225.0	1.5
AS25.4S	25.4	6.4	120.0	1.5
AS31.8S	31.8	6.4	88.9	1.7
AS44.5S	44.5	6.4	76.2	1.7
AS50.8S	50.8	6.4	88.9	1.7
AS59.0S	59.0	6.4	101.6	1.7
AS100.0S	100.0	6.4	60.0	1.7

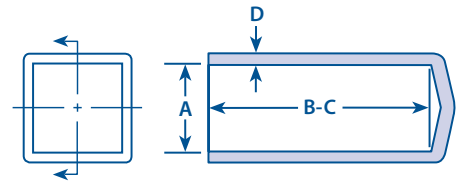

## D Series

### Pull Tab Vinyl Caps

- Flat / Ergonomic Tab for Easy Removal
- Stretches for a Snug Fit, but Won't Split, Tear or Shred
- Available in High-Temp Formula *refer to page 51*
- Material: Black Vinyl *Additional Colours:* ○●●●●●●●●●●

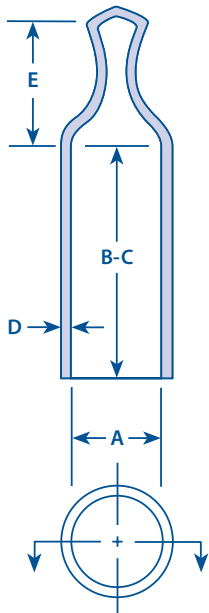

Part #	(A) Inside Diameter	(B) Min Inside Length	(C) Max Inside Length	(D) Wall Thickness	(E) Tab Height	Stocked Length
	mm	mm	mm	mm	mm	mm
D4.8FPTS	4.8	6.4	25.4	1.0	12.7	12.7
D5.5FPTS	5.5	6.4	25.4	1.0	12.7	12.7
D6.0FPTS	6.0	6.4	25.4	1.0	12.7	12.7
D6.4FPTS	6.4	6.4	25.4	1.0	12.7	12.7
D8.0FPTS	8.0	6.4	38.1	1.0	16.6	25.4
D8.7FPTS	8.7	6.4	38.1	1.0	17.7	25.4
D9.5FPTS	9.5	6.4	38.1	1.0	17.7	25.4
D10.3FPTS	10.3	6.4	38.1	1.4	18.0	25.4
D11.1FPTS	11.1	6.4	38.1	1.4	18.4	25.4
D11.7FPTS	11.7	6.4	38.1	1.4	19.1	25.4
D12.7FPTS	12.7	6.4	38.1	1.5	19.1	25.4
D13.5FPTS	13.5	6.4	38.1	1.5	19.4	38.1
D14.3FPTS	14.3	6.4	38.1	1.5	15.6	38.1
D15.9FPTS	15.9	6.4	38.1	1.5	18.0	38.1
D16.6FPTS	16.6	6.4	38.1	1.5	20.6	38.1
D17.5FPTS	17.4	6.4	38.1	1.5	20.6	38.1
D19.0FPTS	19.0	6.4	38.1	1.5	21.0	38.1
D20.6FPTS	20.6	6.4	50.8	1.5	21.3	38.1
D21.4FPTS	21.4	6.4	38.1	1.5	21.5	38.1
D22.2FPTS	22.2	6.4	38.1	1.5	21.5	38.1
D23.8FPTS	23.8	6.4	38.1	1.5	21.7	38.1
D25.4FPTS	25.4	6.4	38.1	1.5	21.8	38.1
D27.0FPTS	27.0	6.4	38.1	1.5	21.8	38.1
D28.6FPTS	28.6	6.4	50.8	1.5	21.8	38.1
D31.8FPTS	31.8	6.4	50.8	1.5	21.8	38.1

**High-Temp**  
Applications  
on pg. 51



**Order Online**  
for fast  
turnaround!

**MOCAP FREE SAMPLES**

8000 856 2466

# Friction Fit Caps & Plugs



## AC Series Vinyl Corner Covers

- Prevents Chipping & Breakage During Transport & Storage
- Snug Fit, but Easily Removed
- Material: See Chart Below for Stocked Vinyl Colours

Additional Colours: ○●●●●●●●●●●●●●●●●

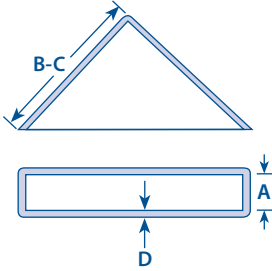

Part #	To Fit Glass Size	(A) Inside Width	(B) Min Length	(C) Max Length	(D) Wall Thickness	Stocked Colour	Stocked Length
	mm	mm	mm	mm	mm		mm
AC1.6S	2	1.6	12.7	50.0	1.4	---	---
AC4.0S	4	4	12.7	50.0	1.5	RED	45.0
AC5.0S	5	5	12.7	50.0	1.5	RED	45.0
AC6.0S	6	6	12.7	50.0	1.5	RED	45.0
AC8.0S	8	8	12.7	50.0	1.5	RED	45.0
AC10.0S	10	10	12.7	50.0	1.5	RED	45.0
AC15.0S	15	15	12.7	50.0	1.9	---	---



## MPSC Series Paper Straight Caps

- Environmentally Friendly & Economical Masking Solution
- Does Not Promote Condensation
- Withstands Up to 204° C (400° F), Ideal for Low-To-High Temp Apps
- Material: Tan Recyclable Paper May Have Minor Dimensional Variation Due to Changes in Relative Humidity



Part #	To Fit MALE NPT	To Fit Tube Size	To Fit STD Thread	To Fit Flared Tube Fitting	To Fit METRIC Thread	To Fit BSP	(C) Inside Diameter	(E) Inside Length
							mm	mm
MPSC001	---	5/16	1/4, 5/16	1/8	M8, M9	G1/8	7.7	9.4
MPSC003	1/8	3/8	3/8, 7/16	3/16	M10, M11	G1/8	9.0	9.5
MPSC004	1/8	7/16	7/16, 1/2	1/4	M11, M12	---	10.6	11.5
MPSC005	1/4	1/2	1/2, 9/16	5/16	M14, M15	G1/4	11.9	13.0
MPSC006	3/8	5/8	5/8, 11/16	3/8	M16, M17, M18	G3/8	15.2	13.4
MPSC007	1/2	3/4	3/4, 13/16	1/2	M20	G1/2	18.2	17.1
MPSC009	---	7/8	7/8, 15/16	5/8	M22	G5/8	20.6	20.9
MPSC010	3/4	1	1, 1-1/16	3/4	M25, M26, M27	G3/4	24.3	21.9
MPSC011	1	1-5/16	1-1/4, 1-5/16	1	M32, M33	G1	30.6	25.3
MPSC013	1-1/4	1-5/8	1-9/16, 1-5/8	1-1/4	M40, M42	G1-1/4	39.2	30.4
MPSC016	---	1-7/8	1-7/8	1-1/2	M48	G1-1/2	46.4	23.2

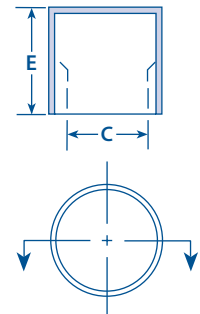

NOTE: Part dimensions are typical from a measured lot. • Individual pieces may vary. • Due to the material, this product may have minor dimensional variation due to changes in relative humidity. • Flange concentricity may vary. • Due to paper's natural structure, the product may be oblong in free state. This will generally aid in the product's retention capability.

## MOCAP Stocked Parts

We keep many varieties of our caps, plugs and grips in stock and ready to ship. All of our stock items are available in Box, Mini-Pack and Micro-Pack quantities and can be ordered online for faster turnaround.

[www.mocap.co.uk](http://www.mocap.co.uk)



# Friction Fit Caps & Plugs



## CMCP Series Vinyl Insertion Plugs

- Wide Flange for Easy Removal
- Flexible Yet Durable - Won't Split, Tear or Shred
- Available in High Temp Formula *refer to page 54*
- Material: Red Vinyl



**High-Temp**  
Applications  
on pg. 52



Part #	To Fit METRIC Thread	To Fit STD Thread	To Fit NPT Thread	Flange O.D.
				mm
CMCP05S	M6	1/4	---	10.2
CMCP15	M8	5/16	---	11.7
CMCP25	M10	3/8	1/8	12.6
CMCP25S	M12	7/16	---	14.0
CMCP35	M14	1/2	1/4	15.7
CMCP35S	M16	9/16	---	17.3
CMCP45	M18	5/8	3/8	20.5
CMCP55	M20	3/4	1/2	24.4
CMCP55S	M22, M24	7/8	---	26.9
CMCP65	M26, M28	1-1/16	3/4	31.6
CMCP75	M32, M34	1-1/8 - 1-3/16 - 1-1/4	1	38.0

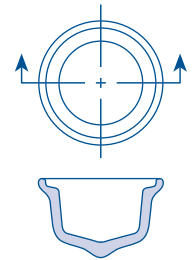

**For Maximum Temperature Specifications, please see page 66.**



## S Series Straight Caps

- Designed to Cap Outside Diameters
- Snug Fit for Threaded or Non-Threaded Tubes, Rods & Fittings
- Material: Red Low-Density Polyethylene



Part #	(A) Inside Diameter	(B) Inside Length
	mm	mm
S-1/8RD1	3.1	15.9
S-5/32RD1	3.9	15.9
S-3/16RD1	4.7	15.9
S-1/4RD1	6.2	22.2
S-5/16RD1	7.8	22.2
S-3/8RD1	9.4	22.2
S-7/16RD1	11.0	22.2
S-1/2RD1	12.5	22.2
S-9/16RD1	14.2	22.2
S-5/8RD1	15.7	22.2
S-11/16RD1	17.3	22.2
S-3/4RD1	18.9	22.2
S-13/16RD1	20.4	22.2
S-7/8RD1	22.0	22.2
S-15/16RD1	23.5	25.4
S-1RD1	25.0	25.4

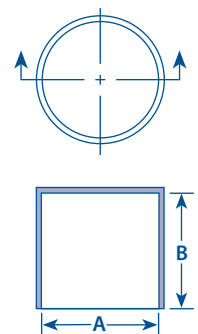

For More Information, Please Contact Sales on  
**0800 856 2466**



# Friction Fit Caps & Plugs



## FCS Series Flanged Caps for Straight Threads

- Flanged for Easy Removal
- Use as Thread Protector or End Cap
- Material: Natural Low-Density Polyethylene



Part #	To Fit STD Thread	(A) Inside Diameter	(B) Inside Length	(C) Flange O.D.
		mm	mm	mm
FCS7/16NA1	7/16	10.9	11.9	17.5
FCS1/2NA1	1/2	12.4	11.9	19.1
FCS9/16NA1	9/16	14	12.7	20.6
FCS11/16NA1	11/16	17.2	12.7	23.9
FCS3/4NA1	3/4	18.7	17.0	25.4
FCS13/16NA1	13/16	20.4	14.2	26.9
FCS7/8NA1	7/8	21.9	16.8	28.4
FCS1NA1	1	25.1	16.8	31.8
FCS1-1/16NA1	1-1/16	26.7	19.1	33.3
FCS1-3/16NA1	1-3/16	29.8	19.1	36.6
FCS1-5/16NA1	1-5/16	33	19.1	39.6
FCS1-7/16NA1	1-7/16	36.2	19.1	42.9
FCS1-5/8NA1	1-5/8	40.9	21.6	47.8

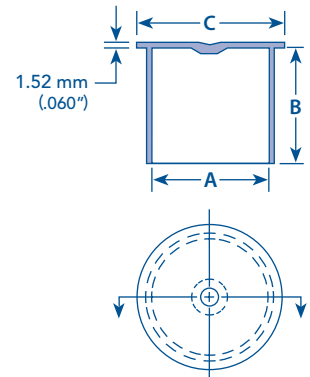

## FCM Series Flanged Caps for Metric Threads

- Flanged for Easy Removal
- Use as Thread Protector or End Cap
- Material: Natural Low-Density Polyethylene

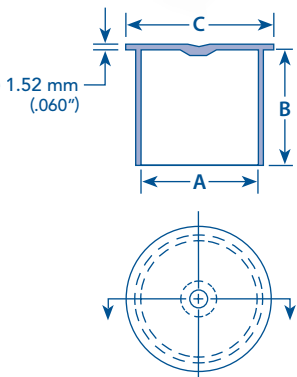

Part #	To Fit METRIC Thread	(A) Inside Diameter	(B) Inside Length	(C) Flange O.D.
		mm	mm	mm
FCM-5NA1	M5	4.9	15.0	12.5
FCM-6NA1	M6	5.9	20.0	13.5
FCM-8NA1	M8	7.8	20.0	15.5
FCM-10NA1	M10	9.8	8.2	17.5
FCM-12NA1	M12	11.8	11.9	19.5
FCM-14NA1	M14	13.7	11.9	21.5
FCM-16NA1	M16	15.7	11.9	23.5
FCM-18NA1	M18	17.7	11.9	25.5
FCM-20NA1	M20	19.7	14.1	27.5
FCM-22NA1	M22	21.7	14.1	29.5
FCS1-1/16NA1	M27	26.7	19.1	33.3
FCS1-3/16NA1	M30	29.8	19.1	36.6
FCM-33NA1	M33	32.6	17.5	40.5

For More Information, Please Contact Sales on  
**0800 856 2466**



# Friction Fit Caps & Plugs



## FCBN Series Flanged Caps for BSP & NPT Threads

- Flanged for Easy Removal
- Use as Thread Protector or End Cap
- Material: Natural Low-Density Polyethylene



Part #	To Fit NPT Thread	To Fit BSP Thread	(A) Inside Diameter	(B) Small I.D.	(C) Length	(D) Flange O.D.
			mm	mm	mm	mm
FCB0125NA1	---	1/8	9.9	8.7	9.7	16.5
FCN0125NA1	1/8	---	10.1	9.7	9.7	16.8
FCBN0250NA1	1/4	1/4	13.5	12.9	13.5	20.6
FCB0375NA1	---	3/8	16.8	15.6	13.5	23.6
FCN0375NA1	3/8	---	17.0	15.3	16.4	23.9
FCBN0500NA1	1/2	1/2	21.2	20.3	18.3	27.7
FCBN0750NA1	3/4	3/4	26.5	25.7	19.1	33.3
FCBN1000NA1	1	1	33.3	32.2	23.6	39.6
FCBN1250NA1	1-1/4	1-1/4	42.0	40.9	24.6	49.3
FCB1500NA1	---	1-1/2	47.9	46.7	24.6	54.6
FCBN1500NA1	1-1/2	1-1/2	48.1	46.9	24.6	54.9
FCB2000NA1	---	2	59.7	58.5	26.2	66.3
FCN2000NA1	2	---	60.2	59.0	59.0	66.5

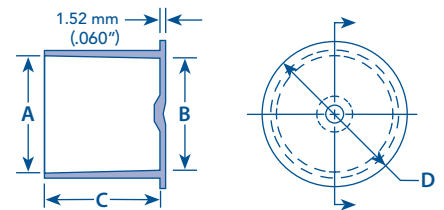

## FCSL Series Long Flanged Caps for Straight Threads

- Protect Straight Threads with or without O-Rings
- Flanged for Easy Removal
- Use as Thread Protector or End Cap
- Material: Red Low-Density Polyethylene

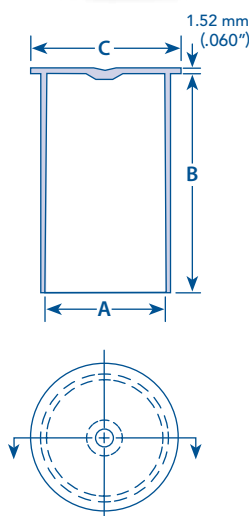

Part #	To Fit STD Thread	(A) Inside Diameter	(B) Inside Length	(C) Flange O.D.
		mm	mm	mm
FCSL5/16RD1	5/16	7.8	31.5	11.7
FCSL3/8RD1	3/8	9.4	31.5	13.2
FCSL7/16RD1	7/16	10.9	33.8	14.7
FCSL1/2RD1	1/2	12.4	33.8	16.3
FCSL9/16RD1	9/16	14.0	35.8	17.8
FCSL3/4RD1	3/4	18.8	39.6	22.4
FCSL7/8RD1	7/8	21.9	43.2	25.7
FCSL1-1/16RD1	1-1/16	26.6	48.0	30.2
FCSL1-5/16RD1	1-5/16	33.0	48.0	36.6
FCSL1-5/8RD1	1-5/8	40.9	48.8	44.7
FCSL1-7/8RD1	1-7/8	47.3	49.3	51.1

## MOCAP Stocked Parts

We keep many varieties of our caps, plugs and grips in stock and ready to ship. All of our stock items are available in Box, Mini-Pack and Micro-Pack quantities and can be ordered online for faster turnaround.

[www.mocap.co.uk](http://www.mocap.co.uk)



0800 856 2466

# Friction Fit Caps & Plugs



## TCS Series Tear Caps for Straight Threads

- Secure Fit Until Removed by Pulling Tab and Breaking Seal
- Use as Shipping Cap, End Cap or Thread Protector
- Material: Red Low-Density Polyethylene

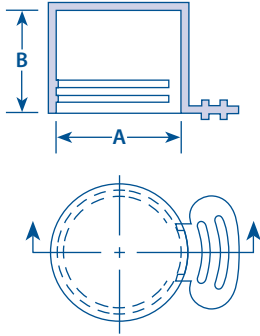

Part #	To Fit STD Thread	(A) Inside Diameter	(B) Inside Length
		mm	mm
TCS0375RD1	3/8 - 24	9.4	11.2
TCS0437RD1	7/16 - 20	10.9	11.2
TCS0500RD1	1/2 - 20	12.6	11.7
TCS0562RD1	9/16 - 20	14.2	12.2
TCS0625RD1	5/8 - 18	15.6	12.2
TCS0687RD1	11/16 - 16	17.3	12.2
TCS0750RD1	3/4 - 16	18.8	14.2
TCS0812RD1	13/16 - 12	20.4	16.3
TCS0875RD1	7/8 - 14	22.0	17.8
TCS1000RD1	1 - 14	25.2	16.5
TCS1062RD1	1-1/16 - 12	26.7	21.1
TCS1187RD1	1-3/16 - 12	30.0	19.1
TCS1312RD1	1-5/16 - 12	33.1	19.1
TCS1437RD1	1-7/16 - 12	36.3	19.1



## TCM Series Tear Caps for Metric Threads

- Secure Fit Until Removed by Pulling Tab and Breaking Seal
- Use as Shipping Cap, End Cap or Thread Protector
- Material: Red Low-Density Polyethylene

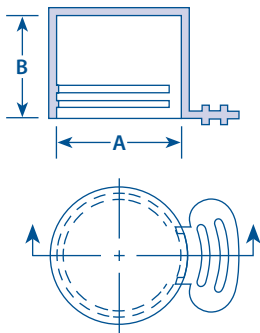

Part #	To Fit METRIC Thread	(A) Inside Diameter	(B) Inside Length
		mm	mm
TCM12RD1	M12	12.0	12.0
TCM14RD1	M14	14.0	14.0
TCM16RD1	M16	16.0	16.2
TCM18RD1	M18	18.0	18.6
TCM20RD1	M20	20.0	20.0
TCM22RD1	M22	22.0	13.4

For More Information, Please Contact Sales on

**0800 856 2466**

# Friction Fit Caps & Plugs



## TCBSP Series Tear Caps for BSP Threads

- Secure Fit Until Removed by Pulling Tab and Breaking Seal
- Use as Shipping Cap, End Cap or Thread Protector
- Material: Red Low-Density Polyethylene



Part #	To Fit BSP Thread	(A) Inside Diameter	(B) Inside Length
		mm	mm
TCBSP0250RD1	1/4 - 19	12.9	11.0
TCBSP0375RD1	3/8 - 19	16.4	12.0
TCBSP0500RD1	1/2 - 14	20.7	15.0
TCBSP0625RD1	5/8 - 14	22.6	18.5
TCBSP0750RD1	3/4 - 14	26.1	23.8
TCBSP0875RD1	7/8 - 14	29.9	25.0
TCBSP1000RD1	1 - 11	32.9	18.0

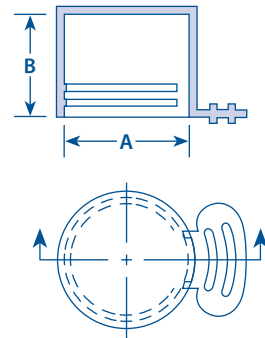

## TCNPT Series Tear Caps for NPT Threads

- Secure Fit Until Removed by Pulling Tab and Breaking Seal
- Use as Shipping Cap, End Cap or Thread Protector
- Material: Red Low-Density Polyethylene



Part #	To Fit NPT Thread	(A) Small I.D.	(B) Large I.D.	(C) Inside Length
		mm	mm	mm
TCNPT0125RD1	1/8	9.8	10.3	8.1
TCNPT0250RD1	1/4	13.0	13.7	12.4
TCNPT0375RD1	3/8	16.3	17.1	12.4
TCNPT0500RD1	1/2	20.3	21.3	16.3
TCNPT0750RD1	3/4	25.5	26.7	16.5
TCNPT1000RD1	1	32.0	33.4	20.6
TCNPT1250RD1	1-1/4	40.7	42.2	21.3
TCNPT1500RD1	1-1/2	46.8	48.3	21.6
TCNPT2000RD1	2	58.8	60.3	22.6
TCNPT2500RD1	2-1/2	70.9	73.0	33.8
TCNPT3000RD1	3	86.6	88.9	35.3

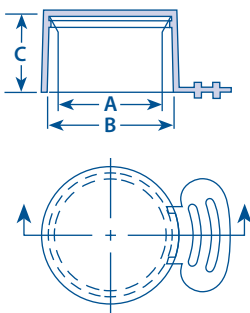

## MOCAP Stocked Parts

We keep many varieties of our caps, plugs and grips in stock and ready to ship. All of our stock items are available in Box, Mini-Pack and Micro-Pack quantities and can be ordered online for faster turnaround.

[www.mocap.co.uk](http://www.mocap.co.uk)

# Friction Fit Caps & Plugs



## BPF Series Barrel Plugs with Flanges

- General Purpose Plug Designed to fit Many Types and Sizes of Internal Threads and Non-Threaded Holes
- Flanged for Easy Removal
- Material: Natural Low-Density Polyethylene

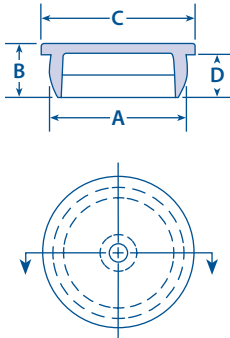

Part #	To Fit STD Thread	To Fit NPT Thread	To Fit METRIC Thread	To Fit METRIC Fine Threads	To Fit BSP Thread	(A) Large Diameter	(B) Overall Length	(C) Flange O.D.	(D) Length
						mm	mm	mm	mm
BPF30NA1	1/4-20	---	---	---	---	5.4	3.8	8.0	2.9
BPF40NA1	5/16-24	1/16	M 8	M 8 X 1	1/16	7.2	8.0	14.0	6.0
BPF50NA1	---	---	---	M 9 X 1	---	8.4	8.0	14.0	6.0
BPF60NA1	3/8-24	---	M 10	---	---	8.6	6.5	14.0	4.5
BPF70NA1	3/8-24	1/8	M 10	---	---	8.6	8.0	18.0	6.0
BPF80NA1	3/8-24	1/8	M 10	M 9.5 X 1	1/8	8.8	9.5	13.0	7.5
BPF90NA1	---	1/8	---	M 10 X 1	1/8	9.2	6.5	14.0	4.5
BPF100NA1	---	---	---	M 10 X 1	---	9.4	6.5	14.0	4.5
BPF110NA1	7/16-20	---	M 12	M 11 X 1	---	10.3	7.5	13.0	5.5
BPF120NA1	---	---	M 12	M 12 X 1.5	---	10.7	7.5	14.0	5.5
BPF130NA1	1/2-20	1/4	---	M12X1, M12X1.25, M13X1.5	1/4	11.7	9.0	16.0	7.0
BPF140NA1	---	---	M 14	M 13 X 1	1/4	12.3	9.0	16.0	7.0
BPF150NA1	9/16-18	---	---	M13.5X1, M14X1.5	---	13.0	9.0	16.0	7.0
BPF160NA1	9/16-18	---	---	M 15 X 1.5	---	13.7	10.0	20.0	8.0
BPF170NA1	5/8-18	---	M 16	M 15 X 1, M16X1.5	---	14.6	7.5	20.0	5.5
BPF180NA1	5/8-18	3/8	---	M 16 X 1.5	---	15.0	10.0	20.0	8.0
BPF190NA1	5/8-18	3/8	---	M 16 X 1.5	---	15.0	7.5	20.0	5.5
BPF200NA1	---	---	M 18	M 16 X 1	3/8	15.6	10.0	20.0	8.0
BPF210NA1	---	---	---	M17X1, M18X1.5, M18X2.5	---	16.5	7.5	22.0	5.5
BPF220NA1	---	---	---	M17X1, M18X1.5, M18X2.5	---	16.5	7.5	20.0	5.5
BPF230NA1	---	---	---	M18X1.5, M18X2.5	---	16.7	7.5	22.0	5.5
BPF240NA1	---	---	---	M 18 X 1.5	---	17.1	10.5	22.0	8.0
BPF241NA1	3/4-16	---	---	---	---	17.9	10.5	25.0	8.0
BPF250NA1	3/4-16	1/2	---	M19X1, M20X2	---	18.4	10.5	25.0	8.0
BPF251NA1	---	1/2	---	M20X1.5	---	18.8	10.5	25.0	8.0
BPF260NA1	---	---	---	M20X1, M21X2	1/2	19.3	10.8	25.0	8.0
BPF270NA1	---	---	M 22	M 21 X 1.5	---	19.6	10.5	25.0	8.0
BPF280NA1	---	---	---	M 22 X 1.5	---	20.7	10.5	25.0	8.0
BPF290NA1	7/8-16	---	M 24	M22X1, M22X1.5	5/8	21.2	10.0	25.0	8.0
BPF300NA1	7/8-16	---	M 24	M22X1, M23X,2	---	21.4	9.5	25.0	7.5
BPF310NA1	---	---	---	M 22 X 1	---	21.7	10.5	25.0	8.0
BPF320NA1	---	---	---	M23X1, M24X2	---	22.4	12.0	28.0	9.0
BPF330NA1	1-14	---	---	M24X1, M25X1.5, M25X2	---	23.6	12.0	28.0	9.0
BPF340NA1	1-14	---	M 25	M 25 X 1.5	---	24.0	12.0	28.0	9.0
BPF350NA1	---	3/4	M 27	M25X1, M26X2	---	24.5	11.0	27.0	8.5



## MOCAP Stocked Parts

We keep many varieties of our caps, plugs and grips in stock and ready to ship. All of our stock items are available in Box, Mini-Pack and Micro-Pack quantities and can be ordered online for faster turnaround.

[www.mocap.co.uk](http://www.mocap.co.uk)



# Friction Fit Caps & Plugs



## BPF Series *(continued)* Barrel Plugs with Flanges

- General Purpose Plug Designed to fit Many Types and Sizes of Internal Threads and Non-Threaded Holes
- Flanged for Easy Removal
- Material: Natural Low-Density Polyethylene



Part #	To Fit STD Thread	To Fit NPT Thread	To Fit METRIC Thread	To Fit METRIC Fine Threads	To Fit BSP Thread	(A) Large Diameter	(B) Overall Length	(C) Flange O.D.	(D) Length
						mm	mm	mm	mm
BPF360NA1	---	3/4	---	M25X1, M26X1.5, M26X2	3/4	24.6	12.0	28.0	9.0
BPF370NA1	1-1/16-12	---	---	M26X1 M27X2	---	25.5	9.5	28.0	7.5
BPF380NA1	---	---	M30	M27X1, M28X2	---	26.5	12.0	28.0	9.0
BPF381NA1	1-3/16-12	---	---	---	7/8	28.4	15.0	36.0	12.0
BPF390NA1	---	---	---	M 30 X 1.5	---	29.0	15.0	36.0	12.0
BPF391NA1	---	1	---	---	---	30.1	15.0	36.0	12.0
BPF400NA1	---	1	---	M31X1, M32X2	1	30.5	15.0	36.0	12.0
BPF410NA1	---	---	---	M 32 X 1.5	1	31.0	15.0	36.0	12.0
BPF411NA1	1-5/16-12	---	---	---	---	31.6	15.0	36.0	12.0
BPF420NA1	---	---	M36	M 33 X 1.5	---	32.0	12.5	36.0	10.0
BPF430NA1	---	---	---	M34X1, M35X2, M36X3	---	33.5	14.0	36.0	12.0
BPF440NA1	---	---	---	M 36 X 1.5	---	34.8	18.0	42.0	15.0
BPF450NA1	---	---	M39	M36X1, M37X2, M38X3	1-1/8	35.5	18.0	42.0	15.0
BPF460NA1	---	---	---	M37X1, M38X2, M39X3	---	36.5	18.0	42.0	15.0
BPF470NA1	---	---	---	M39X1, M40X2	---	38.4	12.5	42.0	10.0
BPF480NA1	---	1-1/4	---	M40X1.5, M42X3	---	39.0	18.0	42.0	15.0
BPF481NA1	1-5/8-12	1-1/4	---	---	1-1/4	39.5	18.0	42.0	15.0
BPF490NA1	---	---	---	---	---	40.0	18.0	42.0	15.0
BPF500NA1	---	---	M45	M42X1.5, M42X2	---	40.7	18.0	45.0	15.0
BPF510NA1	---	---	---	M 45 X 3	---	42.3	18.0	48.0	15.0
BPF511NA1	---	1-1/2	---	---	1-1/2	44.9	18.0	52.0	15.0
BPF520NA1	1-7/8-12	---	---	M 50 X 4	1-1/2	46.0	21.0	55.0	18.0
BPF530NA1	---	---	---	M 50 X 2	---	28.5	15.0	55.0	12.0
BPF531NA1	2-12	---	---	---	---	49.1	21.0	55.0	18.0
BPF540NA1	---	---	---	M 52 X 1	1-3/4	51.5	21.0	55.0	18.0
BPF550NA1	---	---	---	M 56 X 1.5	---	55.0	21.0	63.0	18.0
BPF551NA1	2-1/4-12	---	---	---	---	55.4	21.0	63.0	18.0
BPF560NA1	2-1/4-12	---	---	M 56 X 1	---	55.8	21.0	63.0	18.0
BPF561NA1	---	2	---	---	2	57.1	21.0	63.0	18.0
BPF570NA1	---	---	M 64	M 62 X 4	---	58.0	21.0	63.0	18.0
BPF580NA1	---	---	---	M 60 X 1.5	---	59.0	21.3	63.0	18.0
BPF581NA1	2-1/2-12	---	---	---	---	61.8	21.4	67.0	18.0
BPF590NA1	---	---	---	M 70 X 4	---	66.0	21.5	71.0	18.0
BPF600NA1	---	---	---	M72X1.5, M75X4	---	71.0	22.0	78.0	18.0
BPF620NA1	---	---	---	M 90 X 4	---	86.0	19.3	95.0	18.0

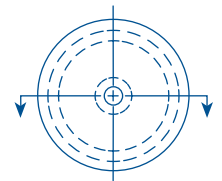
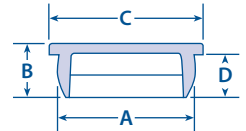

For More Information, Please Contact Sales on

**0800 856 2466**

# Friction Fit Caps & Plugs



## RNS Series Round Tubing Plugs for Standard Tubes

- Multiple Ribs for a Secure Fit
- Heavy End Walls for Durability & Abrasion Resistance
- Material: Black Low-Density Polyethylene

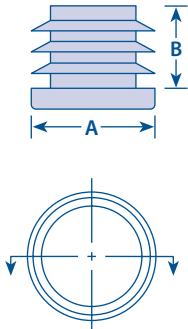

# MOCAP®

## Round Tubing Plugs

- For Standard and Metric Sizes
- Multiple Ribs for Secure Fit
- Tube Plugs Fit Multiple Gauges



Part #	(A) External Tube Size	(B) Length	Tube Wall
	mm	mm	
RN1/2ABK1	12.7	11.0	16-20ga (.065" - .035") 0.8 - 1.6mm
RN5/8CBK1	15.9	11.0	14-20ga (.083" - .035") 0.8 - 2.1mm
RN3/4CBK1	19.1	11.0	14-20ga (.083" - .035") 0.8 - 2.1mm
RN7/8CBK1	22.2	11.0	14-20ga (.083" - .035") 0.8 - 2.1mm
RN7/8DBK1	22.2	11.2	10-14ga (.134" - .083") 2.1 - 3.4mm
RN1DBK1	25.4	11.0	10-14ga (.134" - .083") 2.1 - 3.4mm
RN1CBK1	25.4	11.0	14-20ga (.083" - .035") 0.8 - 2.1mm
RN1-1/8CBK1	28.6	13.0	14-20ga (.083" - .035") 0.8 - 2.1mm
RN1-1/4CBK1	31.8	13.0	14-20ga (.083" - .035") 0.8 - 2.1mm
RN1-1/4DBK1	31.8	13.2	10-14ga (.134" - .083") 2.1 - 3.4mm
RN1-1/2CBK1	38.1	13.0	14-20ga (.083" - .035") 0.8 - 2.1mm
RN1-1/2DBK1	38.1	13.2	10-14ga (.134" - .083") 2.1 - 3.4mm
RN1-1/2QBK1	38.1	13.2	8-12ga (.165" - .109") 2.7 - 4.1mm
RN1-5/8DBK1	41.3	12.7	10-14ga (.134" - .083") 2.1 - 3.4mm
RN1-5/8CBK1	41.3	13.0	14-20ga (.083" - .035") 0.8 - 2.1mm
RN1-3/4CBK1	44.5	15.0	14-20ga (.083" - .035") 0.8 - 2.1mm
RN2DBK1	50.8	15.0	10-14ga (.134" - .083") 2.1 - 3.4mm
RN2CBK1	50.8	15.0	14-20ga (.083" - .035") 0.8 - 2.1mm
RN2-1/8EBK1	54.0	17.0	10-16ga (.134" - .065") 1.6 - 3.4mm
RN2-1/4DBK1	57.2	17.0	10-14ga (.134" - .083") 2.1 - 3.4mm
RN2-1/4CBK1	57.2	17.5	14-20ga (.083" - .035") 0.8 - 2.1mm
RN2-3/8DBK1	60.3	17.0	10-14ga (.134" - .083") 2.1 - 3.4mm
RN2-1/2CBK1	63.5	18.0	14-20ga (.083" - .035") 0.8 - 2.1mm
RN2-1/2FBK1	63.5	18.0	8-12ga (.165" - .109") 2.7 - 4.1mm
RN2-3/4SBK1	69.9	21.3	7-14ga (.180" - .083") 2.1 - 4.5mm
RN3TBK1	76.2	21.3	13-17ga (.095" - .058") 1.4 - 2.4mm
RN3-1/2UBK1	88.9	19.6	6-13ga (.203" - .095") 2.4 - 5.1mm
RN4EBK1	101.6	25.4	10-16ga (.134" - .065") 1.6 - 3.4mm
RN4GBK1	101.6	25.4	4-8ga (0.238" - 0.165") 4.1 - 6.0mm
RN4-3/4JBK1	120.7	25.4	8-14ga (0.165" - 0.083") 2.1 - 4.1mm

## MOCAP® Stocked Parts

We keep many varieties of our caps, plugs and grips in stock and ready to ship. All of our stock items are available in Box, Mini-Pack and Micro-Pack quantities and can be ordered online for faster turnaround.

[www.mocap.co.uk](http://www.mocap.co.uk)

# Friction Fit Caps & Plugs



## RNM Series Round Tubing Plugs for Metric Tubes

- Multiple Ribs for a Secure Fit
- Heavy End Walls for Durability & Abrasion Resistance
- Material: Black Low-Density Polyethylene



Part #	(A) External Tube Size	(B) Length	Tube Wall
	mm	mm	
RN10MABK1	10.0	11.0	1-2mm
RN12MABK1	12.0	11.0	1-2mm
RN13MABK1	13.0	11.0	1-2mm
RN14MABK1	14.0	11.0	1-2mm
RN15MABK1	15.0	11.0	1-2mm
RN5/8CBK1	15.9	11.0	14-20ga (.083" - .035") 0.8 - 2.1mm
RN18MABK1	18.0	11.0	1-2mm
RN20MABK1	20.0	11.0	1-2mm
RN22MABK1	22.0	14.0	1-2mm
RN1CBK1	25.4	11.0	14-20ga (.083" - .035") 0.8 - 2.1mm
RN27MABK1	27.0	14.0	1-2mm
RN28MABK1	28.0	14.0	1-2mm
RN30MABK1	30.0	14.0	1-2mm
RN1-1/4CBK1	31.8	13.0	14-20ga (.083" - .035") 0.8 - 2.1mm
RN34MABK1	34.0	14.0	1-2mm
RN35MABK1	35.0	14.0	1-2mm
RN36MABK1	36.0	14.0	1-2mm
RN1-1/2CBK1	38.1	13.0	14-20ga (.083" - .035") 0.8 - 2.1mm
RN40MABK1	40.0	14.0	1-2mm
RN42MABK1	42.0	14.0	1-2mm
RN45MABK1	45.0	14.0	1-2mm
RN48MABK1	48.0	14.0	1-2mm
RN50MABK1	50.0	17.0	1-2mm
RN55MABK1	55.0	17.0	1-2mm
RN60MABK1	60.0	17.0	1-2mm
RN60MFBK1	60.0	17.0	2-3mm
RN70MFBK1	70.0	17.0	2-3mm
RN70MGBK1	70.0	17.0	3-4mm
RN76MFBK1	76.0	17.0	2-3mm
RN76MGBK1	76.0	17.0	3-4mm
RN90MFBK1	90.0	17.0	2-3mm
RN90MGBK1	90.0	17.0	3-4mm
RN102MFBK1	102.0	17.0	2-3mm
RN102MGBK1	102.0	17.0	3-4mm

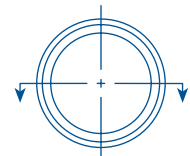
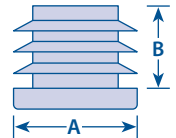

For More Information, Please Contact Sales on  
**0800 856 2466**

# Friction Fit Caps & Plugs



## SQS Series Square Tubing Plugs for Standard Tubes

- Multiple Ribs for a Secure Fit
- Heavy End Walls for Durability & Abrasion Resistance
- Material: Black Low-Density Polyethylene

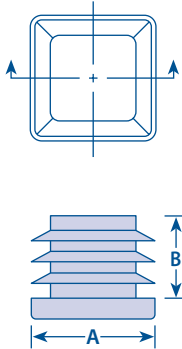

Part #	(A) External Tube Size	(B) Length	Tube Wall
	mm	mm	
SQ1/2BBK1	12.7	11.9	16-18ga (.065" - .049") 1.2 - 1.6mm
SQ5/8CBK1	15.9	11.9	14-20ga (.083" - .035") 0.8 - 2.1mm
SQ3/4DBK1	19.1	10.9	10-14ga (.134" - .083") 2.1 - 3.4mm
SQ3/4CBK1	19.1	11.3	14-20ga (.083" - .035") 0.8 - 2.1mm
SQ7/8CBK1	22.2	11.3	14-20ga (.083" - .035") 0.8 - 2.1mm
SQ1DBK1	25.4	11.3	10-14ga (.134" - .083") 2.1 - 3.4mm
SQ1CBK1	25.4	11.3	14-20ga (.083" - .035") 0.8 - 2.1mm
SQ1-1/8CBK1	28.6	11.3	14-20ga (.083" - .035") 0.8 - 2.1mm
SQ1-1/4CBK1	31.8	11.3	14-20ga (.083" - .035") 0.8 - 2.1mm
SQ1-3/8DBK1	34.9	13.2	10-14ga (.134" - .083") 2.1 - 3.4mm
SQ1-3/8CBK1	34.9	13.2	14-20ga (.083" - .035") 0.8 - 2.1mm
SQ1-1/2DBK1	38.1	14.6	10-14ga (.134" - .083") 2.1 - 3.4mm
SQ1-1/2CBK1	38.1	14.6	14-20ga (.083" - .035") 0.8 - 2.1mm
SQ1-3/4CBK1	44.5	14.6	14-20ga (.083" - .035") 0.8 - 2.1mm
SQ1-3/4DBK1	44.5	13.2	10-14ga (.134" - .083") 2.1 - 3.4mm
SQ2DBK1	50.8	14.6	10-14ga (.134" - .083") 2.1 - 3.4mm
SQ2CBK1	50.8	14.6	14-20ga (.083" - .035") 0.8 - 2.1mm
SQ2GBK1	50.8	13.2	4-8ga (0.238" - 0.165") 4.1 - 6.0mm
SQ2-1/4DBK1	57.2	14.6	10-14ga (.134" - .083") 2.1 - 3.4mm
SQ2-1/2DBK1	63.5	14.2	10-14ga (.134" - .083") 2.1 - 3.4mm
SQ2-1/2IBK1	63.5	14.2	16-23ga (.065" - .025") 0.6 - 1.6mm
SQ2-1/2HBK1	63.5	14.2	6-10ga (.203" - .134") 3.4 - 5.1mm
SQ2-3/4CBK1	69.9	16.5	14-20ga (.083" - .035") 0.8 - 2.1mm
SQ2-3/4JBK1	69.9	18.5	8-14ga (0.165" - 0.083") 2.1 - 4.1mm
SQ3KBK1	76.2	13.2	3-7ga (0.259" - 0.180") 4.5 - 6.5mm
SQ3-1/8OBK1	79.4	24.6	6-11ga (.203" - .120") 3.0 - 5.1mm
SQ3-1/2CBK1	88.9	17.5	14-20ga (.083" - .035") 0.8 - 2.1mm
SQ3-1/2MBK1	88.9	17.5	6-14ga (.203" - .083") 2.1 - 5.1mm
SQ3-1/2LBK1	88.9	17.5	6ga (.203") 5.1mm
SQ3-7/8GBK1	98.4	25.4	4-8ga (0.238" - 0.165") 4.1 - 6.0mm
SQ4NBK1	101.6	23.1	4-11ga (0.238" - 0.120") 3.0 - 6.0mm
SQ4-3/4OBK1	120.7	25.4	6-11ga (.203" - .120") 3.0 - 5.1mm
SQ5PBK1	127.0	24.9	3-10ga (0.259"-0.134") 3.4 - 6.5mm
SQ6PBK1	152.4	24.9	3-10ga (0.259"-0.134") 3.4 - 6.5mm



For More Information, Please Contact Sales on  
**0800 856 2466**

# Friction Fit Caps & Plugs



## SQM Series Square Tubing Plugs for Metric Tubes

- Multiple Ribs for a Secure Fit
- Heavy End Walls for Durability & Abrasion Resistance
- Material: Black Low-Density Polyethylene



Part #	(A) External Tube Size	(B) Length	Tube Wall
	mm	mm	
SQ10MBBK1	10.0	11.0	1.5 - 2mm
SQ12MBBK1	12.0	11.0	1.5 - 2mm
SQ15MBBK1	15.0	11.0	1.5 - 2mm
SQ5/8CBK1	15.9	11.0	14-20ga (.083" - .035") 0.8 - 2.1mm
SQ18MBBK1	18.0	11.0	1.5 - 2mm
SQ20MBBK1	20.0	11.0	1.5 - 2mm
SQ7/8CBK1	22.2	11.0	14-20ga (.083" - .035") 0.8 - 2.1mm
SQ1DBK1	25.4	11.0	10-14ga (.134" - .083") 2.1 - 3.4mm
SQ1CBK1	25.4	11.0	14-20ga (.083" - .035") 0.8 - 2.1mm
SQ30MBBK1	30.0	14.0	1.5 - 2mm
SQ30MCBK1	30.0	14.0	3mm
SQ34MBBK1	34.0	14.0	1.5 - 2mm
SQ34MCBK1	34.0	14.0	3mm
SQ40MBBK1	40.0	14.0	1.5 - 2mm
SQ40MCBK1	40.0	14.0	3mm
SQ40MDBK1	40.0	14.0	4mm
SQ40MEBK1	40.0	14.0	5mm
SQ45MBBK1	45.0	14.0	1.5 - 2mm
SQ50MBBK1	50.0	14.0	1.5 - 2mm
SQ50MCBK1	50.0	14.0	3mm
SQ50MEBK1	50.0	14.0	5mm
SQ60MBBK1	60.0	14.0	1.5 - 2mm
SQ60MDBK1	60.0	14.0	4mm
SQ60MEBK1	60.0	14.0	5mm
SQ70MCBK1	70.0	17.0	3mm
SQ70MDBK1	70.0	17.0	4mm
SQ80MCBK1	80.0	17.0	3mm
SQ90MBBK1	90.0	17.0	1.5 - 2mm
SQ90MEBK1	90.0	17.0	5mm
SQ100MCBK1	100.0	17.0	3mm
SQ100MEBK1	100.0	17.0	5mm
SQ120MEBK1	120.0	17.0	5mm

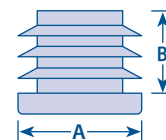
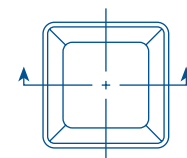

## MOCAP Stocked Parts

We keep many varieties of our caps, plugs and grips in stock and ready to ship. All of our stock items are available in Box, Mini-Pack and Micro-Pack quantities and can be ordered online for faster turnaround.

[www.mocap.co.uk](http://www.mocap.co.uk)

# Friction Fit Caps & Plugs



## RCS Series Rectangular Tubing Plugs for Standard Tubes

- Multiple Ribs for a Secure Fit
- Heavy End Walls for Durability & Abrasion Resistance
- Material: Black Low-Density Polyethylene

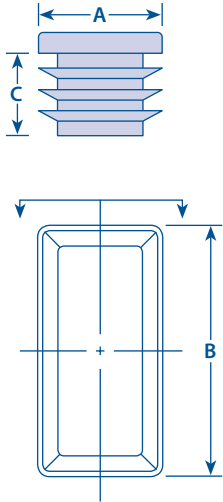

Part #	(A) External Tube Size	(B) External Tube Size	(C) Length	Tube Wall
	mm	mm	mm	
RC1/2X1BBK1	12.7	25.4	10.9	16-18ga (.065" - .049") 1.2 - 1.6mm
RC1/2X1-1/2CBK1	12.7	38.1	12.7	14-20ga (.083" - .035") 0.8 - 2.1mm
RC5/8X1-3/8CBK1	15.9	34.9	10.9	14-20ga (.083" - .035") 0.8 - 2.1mm
RC3/4X1-1/2CBK1	19.1	38.1	10.9	14-20ga (.083" - .035") 0.8 - 2.1mm
RC1X1-1/4CBK1	25.4	31.8	12.7	14-20ga (.083" - .035") 0.8 - 2.1mm
RC1X1-1/2DBK1	25.4	38.1	12.7	10-14ga (.134" - .083") 2.1 - 3.4mm
RC1X1-1/2CBK1	25.4	38.1	12.7	14-20ga (.083" - .035") 0.8 - 2.1mm
RC1X2DBK1	25.4	50.8	12.7	10-14ga (.134" - .083") 2.1 - 3.4mm
RC1X2CBK1	25.4	50.8	12.7	14-20ga (.083" - .035") 0.8 - 2.1mm
RC1X2-1/2CBK1	25.4	63.5	11.4	14-20ga (.083" - .035") 0.8 - 2.1mm
RC1X3CBK1	25.4	76.2	12.7	14-20ga (.083" - .035") 0.8 - 2.1mm
RC1-1/2X2DBK1	38.1	50.8	12.7	10-14ga (.134" - .083") 2.1 - 3.4mm
RC1.50X2.50EBK1	38.1	63.5	13.5	12-16ga (.109" - .065") 1.6 - 2.7mm
RC1-1/2X3DBK1	38.1	76.2	15.2	10-14ga (.134" - .083") 2.1 - 3.4mm
RC1.50X3.50DBK1	38.1	88.9	12.7	10-14ga (.134" - .083") 2.1 - 3.4mm
RC2X2-1/2DBK1	50.8	63.5	13.2	10-14ga (.134" - .083") 2.1 - 3.4mm
RC2X3CBK1	50.8	76.2	12.7	14-20ga (.083" - .035") 0.8 - 2.1mm
RC2X3DBK1	50.8	76.2	13.2	10-14ga (.134" - .083") 2.1 - 3.4mm
RC2X3VBK1	50.8	76.2	13.2	6-8ga (.203" - .165") 4.1 - 5.1mm
RC2X4DBK1	50.8	101.6	12.7	10-14ga (.134" - .083") 2.1 - 3.4mm
RC2X4CBK1	50.8	101.6	12.7	14-20ga (.083" - .035") 0.8 - 2.1mm
RC2X5DBK1	50.8	127.0	25.4	10-14ga (.134" - .083") 2.1 - 3.4mm
RC2X5FBK1	50.8	127.0	25.4	8ga (0.165") 4.1mm
RC3X4VBK1	76.2	101.6	24.9	6-8ga (.203" - .165") 4.1 - 5.1mm



### MOCAP Stocked Parts

We keep many varieties of our caps, plugs and grips in stock and ready to ship. All of our stock items are available in Box, Mini-Pack and Micro-Pack quantities and can be ordered online for faster turnaround.

[www.mocap.co.uk](http://www.mocap.co.uk)

For More Information, Please Contact Sales on

**0800 856 2466**

# Friction Fit Caps & Plugs

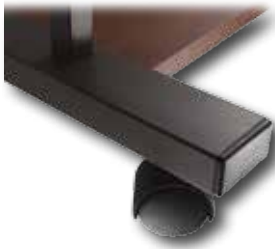

## RCM Series

### Rectangular Tubing Plugs for Metric Tubes

- Multiple Ribs for a Secure Fit
- Heavy End Walls for Durability & Abrasion Resistance
- Material: Black Low-Density Polyethylene



Part #	(A) External Tube Size	(B) External Tube Size	(C) Length	Tube Wall
	mm	mm	mm	
RC2010MBBK1	10.0	20.0	11.0	1.5 - 2mm
RC2015MBBK1	15.0	20.0	11.0	1.5 - 2mm
RC2510MBBK1	10.0	25.0	11.0	1.5 - 2mm
RC2512MBBK1	12.0	25.0	11.0	1.5 - 2mm
RC2515MBBK1	15.0	25.0	11.0	1.5 - 2mm
RC2520MBBK1	20.0	25.0	11.0	1.5 - 2mm
RC3010MBBK1	10.0	30.0	11.0	1.5 - 2mm
RC3015MBBK1	15.0	30.0	11.0	1.5 - 2mm
RC3020MBBK1	20.0	30.0	11.0	1.5 - 2mm
RC3020MCBK1	20.0	30.0	11.0	3mm
RC3025MBBK1	25.0	30.0	14.0	1.5 - 2mm
RC3520MBBK1	20.0	35.0	14.0	1.5 - 2mm
RC3525MBBK1	25.0	35.0	14.0	1.5 - 2mm
RC3530MBBK1	30.0	35.0	14.0	1.5 - 2mm
RC4010MBBK1	10.0	40.0	14.0	1.5 - 2mm
RC4015MBBK1	15.0	40.0	14.0	1.5 - 2mm
RC4020MBBK1	20.0	40.0	14.0	1.5 - 2mm
RC4020MCBK1	20.0	40.0	14.0	3mm
RC4025MBBK1	25.0	40.0	14.0	1.5 - 2mm
RC4030MBBK1	30.0	40.0	14.0	1.5 - 2mm
RC4030MCBK1	30.0	40.0	14.0	3mm
RC4515MBBK1	15.0	45.0	14.0	1.5 - 2mm
RC4520MBBK1	20.0	45.0	14.0	1.5 - 2mm
RC4525MBBK1	25.0	45.0	14.0	1.5 - 2mm
RC4838MBBK1	38.0	48.0	14.0	1.5 - 2mm
RC5020MBBK1	20.0	50.0	14.0	1.5 - 2mm
RC5025MBBK1	25.0	50.0	14.0	1.5 - 2mm
RC5030MBBK1	30.0	50.0	14.0	1.5 - 2mm
RC5030MCBK1	30.0	50.0	14.0	3mm
RC5034MBBK1	34.0	50.0	14.0	1.5 - 2mm
RC5040MBBK1	40.0	50.0	14.0	1.5 - 2mm
RC5535MBBK1	35.0	55.0	14.0	1.5 - 2mm
RC6020MBBK1	20.0	60.0	14.0	1.5 - 2mm
RC6030MBBK1	30.0	60.0	14.0	1.5 - 2mm
RC6030MCBK1	30.0	60.0	14.0	3mm
RC6040MBBK1	40.0	60.0	14.0	1.5 - 2mm
RC6040MDBK1	40.0	60.0	14.0	4mm
RC6040MEBK1	40.0	60.0	14.0	5mm
RC7030MBBK1	30.0	70.0	17.0	1.5 - 2mm
RC7040MBBK1	40.0	70.0	17.0	1.5 - 2mm
RC7040MDBK1	40.0	70.0	17.0	4mm
RC8020MBBK1	20.0	80.0	17.0	1.5 - 2mm
RC8030MBBK1	30.0	80.0	17.0	1.5 - 2mm
RC8040MBBK1	40.0	80.0	17.0	1.5 - 2mm
RC8040MDBK1	40.0	80.0	17.0	4mm
RC8040MEBK1	40.0	80.0	17.0	5mm
RC8050MBBK1	50.0	80.0	17.0	1.5 - 2mm
RC8050MDBK1	50.0	80.0	17.0	4mm
RC8060MBBK1	60.0	80.0	17.0	3mm
RC8060MEBK1	60.0	80.0	17.0	5mm
RC10040MBBK1	40.0	100.0	17.0	1.5 - 2mm
RC10040MCBK1	40.0	100.0	17.0	3mm
RC10050MBBK1	50.0	100.0	17.0	3mm
RC10050MDBK1	50.0	100.0	17.0	4mm
RC10050MEBK1	50.0	100.0	17.0	5mm
RC12040MBBK1	40.0	120.0	17.0	3mm
RC12060MBBK1	60.0	120.0	17.0	3mm
RC12060MDBK1	60.0	120.0	17.0	4mm
RC12060MEBK1	60.0	120.0	17.0	5mm
RC12080MBBK1	80.0	120.0	17.0	1.5 - 2mm
RC14080MDBK1	80.0	140.0	17.0	4mm

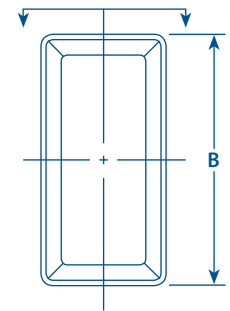
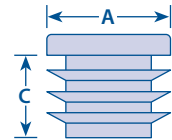

# Friction Fit Caps & Plugs



## SMRS Series

### Sheet Metal Recessed Plugs for Standard Holes

- Snap-in Design for an Attractive and Secure Fit
- Used on Auto Bodies, Tanks, HVAC Units, etc.
- Material: Black Low-Density Polyethylene

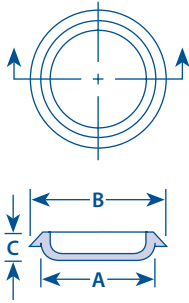
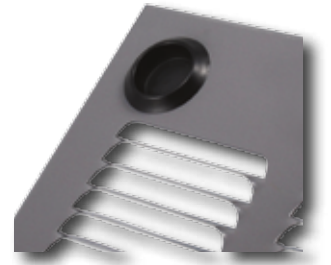

Part #	To Fit Hole Size	Metal Thickness	(A) Small O.D.	(B) Flange O.D.	(C) Length
			mm	mm	mm
SMR1/2BK1	12.70 - 13.46mm (.50"-.53")	.51 - 1.78mm (.02"-.07")	14.0	21.6	7.4
SMR3/4BK1	18.80 - 19.56mm (.74"-.77")	.51 - 3.56mm (.02"-.14")	20.1	29.5	9.1
SMR13/16BK1	20.07 - 21.08mm (.79"-.83")	.51 - 1.78mm (.02"-.07")	21.6	29.2	7.4
SMR7/8BK1	22.10 - 23.11mm (.87"-.91")	.51 - 2.54mm (.02"-.10")	23.6	31.2	8.9
SMR1BK1	25.15 - 26.16mm (.99"-1.03")	.51 - 2.54mm (.02"-.10")	26.7	34.3	8.9
SMR1-1/16BK1	26.42 - 27.43mm (1.04"-1.08")	.51 - 2.54mm (.02"-.10")	27.9	35.6	8.9
SMR1-1/8BK1	28.19 - 29.46mm (1.11"-1.16")	.51 - 4.57mm (.02"-.18")	30.0	38.9	10.9
SMR1-1/4BK1	31.50 - 32.51mm (1.24"-1.28")	.51 - 2.54mm (.02"-.10")	33.0	40.6	8.9
SMR1-3/8BK1	34.54 - 35.81mm (1.36"-1.41")	.51 - 2.54mm (.02"-.10")	36.3	43.9	8.9
SMR1-1/2-7BK1	37.59 - 38.61mm (1.48"-1.52")	3.3 - 5.59mm (.13"-.22")	39.1	46.5	12.7
SMR1-1/2BK1	37.59 - 38.86mm (1.48"-1.53")	.51 - 2.54mm (.02"-.10")	39.4	47	8.9
SMR1-5/8BK1	40.39 - 41.91mm (1.59"-1.65")	.76 - 2.54mm (.03"-.10")	42.7	50.8	9.1
SMR1-3/4BK1	43.69 - 44.96mm (1.72"-1.77")	.51 - 2.54mm (.02"-.10")	45.7	53.3	8.9
SMR1-3/4-5BK1	43.18 - 45.21mm (1.70"-1.78")	.51 - 4.06mm (.02"-.16")	45.7	57.2	10.9
SMR1-13/16BK1	44.96 - 46.23mm (1.77"-1.82")	.51 - 2.54mm (.02"-.10")	47.0	54.9	8.9
SMR1-7/8BK1	46.99 - 48.26mm (1.85"-1.90")	.51 - 2.54mm (.02"-.10")	49.0	56.9	8.9
SMR2BK1	50.04 - 51.31mm (1.97"-2.02")	.51 - 2.54mm (.02"-.10")	52.1	59.7	9.1
SMR2-1/2BK1	62.23 - 63.75mm (2.45"-2.51")	.51 - 2.54mm (.02"-.10")	64.5	72.4	8.9
SMR2-1/2-5BK1	61.98 - 64.26mm (2.44"-2.53")	.51 - 3.56mm (.02"-.14")	64.8	76.2	10.9



For More Information, Please Contact Sales on  
**0800 856 2466**

**MOCAP**  
Sheet Metal Plugs

- Provides a Finished Look
- Snap In Design for a Secure Fit
- Designed for Sheet Metal and Thin Gauge Materials





# Friction Fit Caps & Plugs



## SMFS Series Sheet Metal Flush Plugs for Standard Holes

- Snap-in Design for an Attractive and Secure Fit
- Used on Auto Bodies, Tanks, HVAC Units, etc.
- Material: Black Low-Density Polyethylene



Part #	To Fit Hole Size	Metal Thickness	(A) Small O.D.	(B) Flange O.D.	(C) Length
			mm	mm	mm
SMF3/8BK1	9.40 - 9.65mm (.37" - .38")	.51 - 1.52mm (.02" - .06")	10.4	19.1	4.8
SMF7/16BK1	10.92 - 11.43mm (.43" - .45")	.76 - 1.52mm (.03" - .06")	11.9	17.5	5.6
SMF1/2BK1	12.45 - 13.21mm (.49" - .52")	.76 - 2.03mm (.03" - .08")	13.7	21.8	6.4
SMF9/16BK1	13.97 - 14.73mm (.55" - .58")	.76 - 2.03mm (.03" - .08")	15.2	22.1	6.4
SMF5/8BK1	15.49 - 16.26mm (.61" - .64")	.76 - 2.03mm (.03" - .08")	17.0	23.6	6.6
SMF3/4BK1	18.80 - 19.56mm (.74" - .77")	.76 - 2.79mm (.03" - .11")	20.1	26.9	7.4
SMF7/8BK1	21.84 - 22.61mm (.86" - .89")	.76 - 2.03mm (.03" - .08")	23.1	29.5	6.4
SMF15/16BK1	23.37 - 24.38mm (.92" - .96")	.76 - 2.03mm (.03" - .08")	24.9	33.3	6.4
SMF1BK1	24.38 - 25.91mm (.96" - 1.02")	.76 - 2.03mm (.03" - .08")	26.4	34.8	6.4
SMF1-3/16BK1	29.72 - 30.48mm (1.17" - 1.20")	.76 - 2.03mm (.03" - .08")	31.0	39.6	6.4
SMF1-1/4BK1	31.24 - 32.26mm (1.23" - 1.27")	.76 - 2.03mm (.03" - .08")	32.8	41.1	6.4
SMF1-5/16BK1	33.02 - 33.78mm (1.30" - 1.33")	.76 - 2.03mm (.03" - .08")	34.5	42.7	6.4
SMF1-1/2BK1	37.85 - 38.61mm (1.49" - 1.52")	.76 - 2.03mm (.03" - .08")	39.1	47.8	6.4
SMF1-3/4BK1	43.94 - 44.70mm (1.73" - 1.76")	.76 - 2.03mm (.03" - .08")	45.5	54.1	6.4
SMF2BK1	50.29 - 51.05mm (1.98" - 2.01")	.76 - 2.03mm (.03" - .08")	52.1	62.0	6.4
SMF2-1/8BK1	53.34 - 54.36mm (2.10" - 2.14")	.76 - 2.03mm (.03" - .08")	55.1	63.2	6.4
SMF3BK1	75.44 - 76.71mm (2.97" - 3.02")	.76 - 2.03mm (.03" - .08")	77.7	85.3	6.4
SMF3-1/8BK1	78.74 - 80.01mm (3.10" - 3.15")	.76 - 2.03mm (.03" - .08")	80.8	89.4	6.4
SMF3-3/8BK1	85.09 - 86.36mm (3.35" - 3.40")	.76 - 2.03mm (.03" - .08")	87.1	95.3	7.1
SMF3-1/2BK1	88.14 - 89.41mm (3.47" - 3.52")	.76 - 2.79mm (.03" - .11")	90.4	98.0	7.1
SMF4BK1	100.84 - 102.11mm (3.97" - 4.02")	1.27 - 2.54mm (.05" - .10")	103.4	111.0	7.1

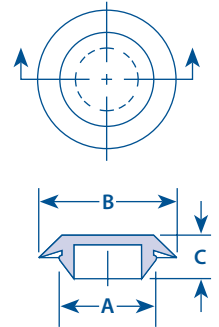

## SMFM Series Sheet Metal Flush Plugs for Metric Holes

- Snap-in Design for an Attractive and Secure Fit
- Used on Auto Bodies, Tanks, HVAC Units, etc.
- Material: Black Low-Density Polyethylene



Part #	To Fit Hole Size	Metal Thickness	(A) Small O.D.	(B) Flange O.D.	(C) Length
			mm	mm	mm
SMF8BK1	7.75 - 8.05mm (.305 - .317")	.8 - 2.0mm (.03" - .08")	8.4	17.8	5.3
SMF10BK1	9.73 - 10.08mm (.383 - .397")	.8 - 2.0mm (.03" - .08")	10.4	19.8	5.3
SMF12BK1	11.68 - 12.24mm (.460 - .482")	.8 - 2.0mm (.03" - .08")	12.5	21.8	5.3
SMF14BK1	13.67 - 14.27mm (.538 - .562")	.8 - 2.0mm (.03" - .08")	14.5	23.9	6.4
SMF16BK1	15.62 - 16.26mm (.615 - .640")	.8 - 2.0mm (.03" - .08")	16.5	25.9	6.4
SMF18BK1	17.65 - 18.42mm (.695 - .725")	.8 - 2.0mm (.03" - .08")	18.5	27.9	6.4
SMF20BK1	19.69 - 20.45mm (.775 - .805")	.8 - 2.0mm (.03" - .08")	20.6	30.0	6.4
SMF22BK1	21.72 - 22.35mm (.855 - .880")	.8 - 2.0mm (.03" - .08")	22.6	32.0	6.4

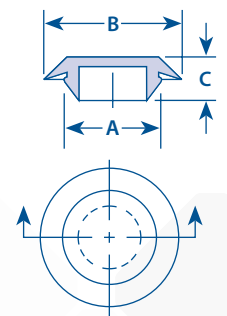

# Friction Fit Caps & Plugs



## LMP Series

### Tapered Plugs for Type L and M Copper Tubing

- Reinforced Cross Bracing for Secure Fit
- Features Durable Pull-Tab for Easy Removal
- Material: Red Low-Density Polyethylene

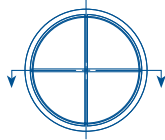
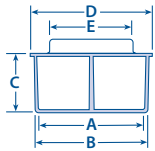

Part #	To Fit Tube Size	(A) Small O.D.	(B) Large O.D.	(C) Length	(D) Flange O.D.	(E) Tab Width
		mm	mm	mm	mm	mm
LMP0375RD1	3/8	8.1	8.4	9.7	9.5	5.5
LMP0500RD1	1/2	10.7	11.2	9.7	12.7	6.6
LMP0625RD1	5/8	13.7	14.2	12.7	15.9	9.6
LMP0750RD1	3/4	16.8	17.5	15.7	19.1	12.4
LMP0875RD1	7/8	19.8	20.6	19.1	22.2	12.6
LMP1125RD1	1-1/8	25.9	26.7	22.4	28.6	19.3
LMP1375RD1	1-3/8	32.0	33.0	25.4	34.9	25.4
LMP1625RD1	1-5/8	38.1	39.1	25.4	41.3	25.4
LMP2125RD1	2-1/8	50.0	51.3	25.4	54.0	37.5
LMP2625RD1	2-5/8	62.2	63.5	25.4	66.7	37.5
LMP3125RD1	3-1/8	74.4	75.9	25.4	79.4	37.5
LMP3625RD1	3-5/8	86.6	87.6	25.4	92.1	50.4
LMP4125RD1	4-1/8	98.8	99.8	25.4	104.8	50.4



## KTP Series

### Tapered Plugs for Type K Copper Tubing

- Reinforced Cross Bracing for Secure Fit
- Features Durable Pull-Tab for Easy Removal
- Material: Red Low-Density Polyethylene

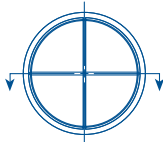
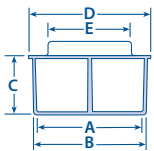

Part #	To Fit Tube Size	(A) Small O.D.	(B) Large O.D.	(C) Length	(D) Flange O.D.	(E) Tab Width
		mm	mm	mm	mm	mm
KTP0375RD1	3/8	7.7	7.9	9.7	9.7	4.8
KTP0500RD1	1/2	10.0	10.5	9.7	12.7	6.4
KTP0625RD1	5/8	13.3	13.8	12.7	16.0	9.7
KTP0750RD1	3/4	16.4	17.2	15.7	19.1	12.7
KTP0875RD1	7/8	18.8	19.6	19.1	22.4	12.7
KTP1125RD1	1-1/8	25.1	25.9	22.4	28.4	18.5
KTP1375RD1	1-3/8	31.5	32.5	25.4	35.1	25.4
KTP1625RD1	1-5/8	37.5	38.5	25.4	41.1	25.4
KTP2125RD1	2-1/8	49.8	51.1	25.4	54.1	36.8
KTP2625RD1	2-5/8	61.5	62.7	25.4	66.8	36.8
KTP3125RD1	3-1/8	73.5	75.0	25.4	79.5	36.8



## GKP Series

### General Purpose Plugs for Type L and M Copper Tubing

- Designed for Flange to Fit Flush with Outside Wall of Tube
- Material: Red Low-Density Polyethylene

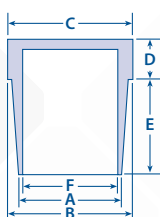

Part #	To Fit Tube Size	(A) Small O.D.	(B) Large O.D.	(C) Flange O.D.	(D) Flange Thickness	(E) Length	(F) Inside Diameter
		mm	mm	mm	mm	mm	mm
GKP0188RD1	3/16	2.7	3.5	4.8	4.8	7.9	1.1
GKP0250RD1	1/4	4.1	5.1	6.1	3.6	9.7	2.5
GKP0313RD1	5/16	5.8	6.9	7.9	3.6	9.7	4.2
GKP0375RD1	3/8	7.4	8.6	9.4	4.1	9.7	5.8
GKP0500RD1	1/2	10.4	11.8	12.7	4.1	9.7	8.8
GKP0625RD1	5/8	13.5	14.9	15.7	4.8	14.2	11.9
GKP0750RD1	3/4	16.5	18.1	19.1	4.8	14.2	14.9

# Tapered Caps & Plugs



## WF Series Wide Flange Tapered Plug Caps

- Featuring a Wider Flange for Added Protection of External Surfaces
- Material: Red Low-Density Polyethylene



Part #	(A) Small O.D.	(B) Large O.D.	(C) Small I.D.	(D) Large I.D.	(E) Length	(F) Flange O.D.
	mm	mm	mm	mm	mm	mm
WF.173/.240RD1	4.4	6.1	2.8	4.5	9.7	14.2
WF.240/.315RD1	6.1	8.0	4.6	6.2	9.1	15.7
WF.302/.375RD1	7.7	9.5	6.1	7.7	9.7	17.5
WF.360/.425RD1	9.1	10.8	7.6	9.2	9.7	19.1
WF.425/.480RD1	10.8	12.2	9.2	10.6	9.7	20.6
WF.472/.540RD1	12.0	13.7	10.4	12.1	11.2	22.4
WF.536/.615RD1	13.6	15.6	12.0	14.0	11.2	23.9
WF.590/.670RD1	15.0	17.0	13.4	15.4	12.7	25.4
WF.643/.726RD1	16.3	18.4	14.8	16.8	12.7	26.2
WF.683/.785RD1	17.3	19.9	15.8	18.4	13.5	28.7
WF.765/.865RD1	19.4	22.0	17.9	20.4	14.2	30.2
WF.820/.930RD1	20.8	23.6	19.3	22.0	15.0	31.8
WF.872/.977RD1	22.1	24.8	20.6	23.3	15.0	33.3
WF.975/1.10RD1	24.8	28.0	23.2	26.5	18.3	36.6
WF1.15/1.27RD1	29.4	32.4	27.8	30.8	18.3	39.6
WF1.17/1.28RD1	29.8	32.6	28.4	31.2	16.0	42.4
WF1.24/1.37RD1	31.6	34.9	30.0	33.4	18.3	42.9
WF1.31/1.47RD1	33.3	37.5	31.8	35.9	22.4	46.0
WF1.45/1.61RD1	37.0	41.0	35.4	39.4	18.3	49.3
WF1.51/1.60RD1	38.5	40.6	36.4	38.5	12.4	57.4
WF1.57/1.68RD1	40.0	42.8	38.4	41.2	17.5	50.8
WF1.73/1.90RD1	44.1	48.3	42.5	46.7	18.3	56.4
WF1.81/1.95RD1	46.0	49.5	44.4	48.0	17.5	58.7
WF1.94/2.10RD1	49.4	53.3	47.8	51.8	17.5	62.0

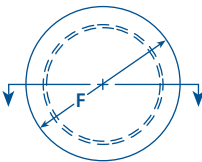
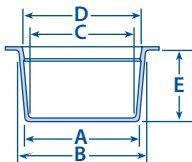

As a Guide for Part Selection, an Application Advisor is Available On Our Website.



# MOCAP®

## Tapered Plug Caps

Designed to Cap Multiple Outer Diameters or to Plug Multiple Inner Diameters



# Tapered Caps & Plugs



## T Series Tapered Plug Caps

- Tapered Design Fits Multiple Diameters
- Dual Function Closure Can Be Used as a Cap or Plug
- Material: Red Low-Density Polyethylene

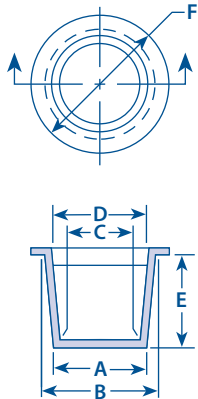

Part #	(A) Small O.D.	(B) Large O.D.	(C) Small I.D.	(D) Large I.D.	(E) Length	(F) Flange O.D.
	mm	mm	mm	mm	mm	mm
T.116/.182RD1	2.9	4.6	1.4	3.1	9.6	7.9
T.145/.205RD1	3.7	5.2	2.0	3.8	9.6	10.4
T.173/.240RD1	4.4	6.1	2.8	4.5	9.6	9.6
T.236/.302RD1	6.0	7.7	4.4	6.1	9.6	11.2
T.267/.335RD1	6.8	8.5	5.2	6.9	9.6	11.9
T.299/.365RD1	7.6	9.3	6.0	7.7	9.6	12.7
T.330/.396RD1	8.4	10.1	6.8	8.5	9.6	13.5
T.361/.427RD1	9.2	10.9	7.6	9.3	9.6	14.2
T.390/.456RD1	9.9	11.6	8.3	10.0	9.6	15.0
T.419/.485RD1	10.6	12.3	9.0	10.7	9.6	16.0
T.447/.513RD1	11.3	13.0	9.8	11.5	9.6	16.8
T.471/.547RD1	12.0	13.9	10.4	12.3	11.2	17.5
T.500/.576RD1	12.7	14.6	11.2	13.1	11.2	18.3
T.532/.608RD1	13.5	15.4	11.9	13.8	11.2	19.1
T.550/.631RD1	14.0	16.0	12.4	14.4	11.9	19.1
T.580/.667RD1	14.7	16.9	13.2	15.4	12.7	20.6
T.610/.695RD1	15.5	17.6	13.9	16.1	12.7	21.3
T.640/.727RD1	16.3	18.5	14.7	16.9	12.7	22.3
T.675/.755RD1	17.2	19.2	15.6	17.6	12.7	22.3
T.690/.788RD1	17.5	20.0	15.9	18.4	14.2	23.9
T.725/.823RD1	18.4	20.9	16.8	19.3	14.2	24.6
T.750/.848RD1	19.1	21.5	17.5	19.9	14.2	25.4
T.802/.911RD1	20.4	23.1	18.8	21.6	16.0	26.9
T.815/.930RD1	20.7	23.6	19.1	22.0	16.0	27.7
T.866/.975RD1	22.0	24.8	20.4	23.2	16.0	28.7
T.915/1.04RD1	23.2	26.4	21.7	24.9	17.5	29.5
T.964/1.09RD1	24.5	27.7	22.9	26.1	19.1	31.8
T.995/1.14RD1	25.3	29.1	23.7	27.5	19.1	33.3
T1.09/1.21RD1	27.8	30.9	26.2	29.3	19.1	35.8
T1.17/1.28RD1	29.9	32.6	28.3	31.0	16.0	36.6
T1.22/1.35RD1	31.1	34.4	29.5	32.8	19.1	38.1
T1.23/1.36RD1	31.4	34.5	29.8	33.0	20.6	38.1
T1.31/1.46RD1	33.3	37.2	31.7	35.6	22.3	41.4
T1.44/1.60RD1	36.8	40.6	35.2	39.0	22.3	44.5
T1.56/1.68RD1	39.6	42.7	38.0	41.2	19.1	47.7
T1.63/1.75RD1	41.4	44.5	39.8	42.9	19.1	49.3
T1.75/1.88RD1	44.5	47.7	42.9	46.2	19.1	50.8
T1.78/1.95RD1	45.2	49.5	43.6	48.0	25.4	54.1
T1.84/2.00RD1	46.8	50.8	45.2	49.2	25.4	54.1
T1.90/2.07RD1	48.3	52.7	46.7	51.1	25.4	57.2
T1.97/2.13RD1	50.2	54.2	48.6	52.6	25.4	57.2
T2.01/2.14RD1	51.2	54.5	49.6	53.0	19.1	58.7
T2.06/2.24RD1	52.5	57.0	50.9	55.4	25.4	62.0
T2.125/2.406RD1	54.0	61.1	52.4	59.5	25.4	64.3
T2.13/2.31RD1	54.1	58.7	52.7	57.2	25.4	65.0
T2.230/2.260RD1	56.6	57.4	55.1	55.8	12.7	63.5
T2.298/2.464RD1	58.4	62.6	56.8	61.0	25.4	66.8
T2.307/2.650RD1	58.6	67.3	57.0	65.7	31.8	70.6
T2.395/2.602RD1	60.8	66.1	59.3	64.5	26.2	71.4



As a Guide for Part Selection, an Application Advisor is Available On Our Website.

### To use as a CAP:

Select a CAP with a "Small I.D." Dimension at least 0.5 mm smaller than the diameter to be capped (increase 1% or more for large diameters).



### To use as a PLUG:

Select a PLUG with a "Large O.D." Dimension at least 0.5 mm larger than the diameter to be plugged (increase 1% or more for large diameters).



# Tapered Caps & Plugs

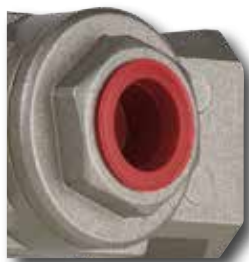

## T Series (continued) Tapered Plug Caps

- Tapered Design Fits Multiple Diameters
- Dual Function Closure Can Be Used as a Cap or Plug
- Material: Red Low-Density Polyethylene



Part #	(A) Small O.D.	(B) Large O.D.	(C) Small I.D.	(D) Large I.D.	(E) Length	(F) Flange O.D.
	mm	mm	mm	mm	mm	mm
T2.457/2.750RD1	62.4	69.9	60.8	68.3	25.4	73.2
T2.480/2.644RD1	63.0	67.2	61.4	65.6	16.0	70.6
T2.555/2.690RD1	64.9	68.3	63.3	66.8	16.0	73.2
T2.641/2.790RD1	67.1	70.9	65.5	69.3	19.1	74.7
T2.760/2.990RD1	70.1	75.9	68.2	74.9	25.4	79.5
T2.849/2.980RD1	72.4	75.7	70.8	74.1	19.1	82.6
T2.975/3.103RD1	75.6	78.8	74.0	77.2	19.1	84.8
T2.982/3.245RD1	75.7	82.4	74.0	80.7	25.4	85.9
T3.090/3.370RD1	78.5	85.6	76.7	83.8	25.4	88.9
T3.270/3.562RD1	83.1	90.5	81.3	88.7	28.7	93.7
T3.325/3.457RD1	84.5	87.8	82.4	85.8	19.1	92.2
T3.470/3.600RD1	88.1	91.4	86.6	89.9	19.1	98.6
T3.55/3.73RD1	90.2	94.7	88.4	93.0	25.4	101.6
T3.68/3.80RD1	93.5	96.5	91.7	94.7	19.1	101.6
T3.79/3.92RD1	96.3	99.6	94.2	97.5	19.1	104.7
T3.93/4.07RD1	99.8	103.4	98.0	101.6	19.1	111.3
T4.02/4.14RD1	102.1	105.2	100.1	103.4	19.1	115.1
T4.09/4.32RD1	103.9	109.7	101.9	107.7	31.8	117.4
T4.27/4.43RD1	108.5	112.5	106.2	110.3	22.4	124.0
T4.37/4.62RD1	111.0	117.4	109.0	115.3	25.4	127.0
T4.64/4.85RD1	117.9	123.2	116.1	121.4	22.4	133.4
T4.79/4.97RD1	121.7	126.2	119.6	124.2	25.4	136.7
T4.91/5.09RD1	124.7	129.3	122.7	127.3	25.4	139.7
T4.99/5.20RD1	126.8	132.1	125.0	129.5	25.4	143.0
T5.18/5.36RD1	131.6	136.1	130.0	134.4	25.4	149.4
T5.33/5.49RD1	135.4	139.5	132.3	136.4	22.4	149.4
T5.47/5.62RD1	139.0	142.8	136.9	140.7	25.4	155.7
T5.57/5.75RD1	141.5	146.1	139.5	144.0	25.4	157.2
T5.70/5.87RD1	144.8	149.1	142.5	147.1	24.9	158.8
T6.01/6.18RD1	152.7	157.0	150.4	154.9	25.4	168.2
T6.18/6.35RD1	157.0	161.3	154.7	159.0	25.4	171.5
T6.40/6.56RD1	162.6	166.6	160.8	164.9	22.1	176.3
T6.61/6.71RD1	167.9	170.4	165.9	168.4	38.1	182.6
T6.67/6.77RD1	169.4	172.1	166.7	169.4	38.1	182.6
T6.88/7.03RD1	174.8	178.6	172.7	176.5	12.7	194.8
T6.94/7.36RD1	176.4	186.9	174.0	184.5	37.1	196.1
T7.05/7.12RD1	179.1	180.8	177.0	179.3	25.4	193.8
T7.34/7.65RD1	186.4	194.3	184.4	192.0	25.4	201.7
T7.66/7.84RD1	194.6	199.1	192.5	197.1	25.4	206.2
T7.97/8.14RD1	202.4	206.8	200.2	204.5	25.4	212.9
T8.15/8.35RD1	207.0	212.1	204.5	209.6	35.1	222.3
T8.40/8.60RD1	213.4	218.4	210.8	215.9	35.1	228.6
T8.67/8.73RD1	220.2	221.7	217.2	218.4	38.1	231.9
T9.06/9.36RD1	230.1	237.8	225.8	234.7	44.5	250.4
T9.97/10.22RD1	253.2	259.6	249.4	256.0	24.6	268.2
T10.79/11.10RD1	274.1	281.9	269.7	277.1	44.5	294.6
T11.11/11.46RD1	282.2	291.1	277.9	287.3	50.8	303.8
T12.79/13.14RD1	324.9	333.8	321.5	328.2	50.8	346.5
T13.25/13.60RD1	336.6	345.4	329.2	338.0	50.8	358.1

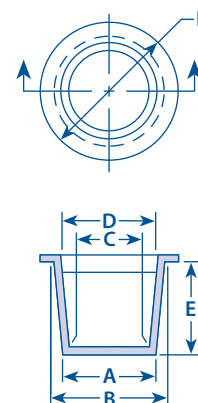

As a Guide for Part Selection, an Application Advisor is Available On Our Website.

For More Information, Please Contact Sales on  
**0800 856 2466**

# Tapered Caps & Plugs



## TWF Series

### Thick Wide Flange Tapered Plug Caps

- Thicker and Wider Flange for Added Durability
- High-Visibility Colour
- Material: Yellow Low-Density Polyethylene

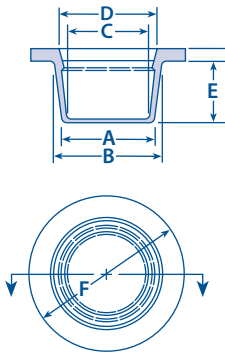

Part #	(A) Small O.D. mm	(B) Large O.D. mm	(C) Small I.D. mm	(D) Large I.D. mm	(E) Length mm	(F) Flange O.D. mm
TWF.116/.182YW1	2.9	4.6	1.4	3.1	9.4	12.7
TWF.173/.240YW1	4.4	6.1	2.8	4.5	9.4	14.2
TWF.236/.296YW1	6.0	7.5	4.4	5.7	7.9	15.8
TWF.299/.365YW1	7.6	9.3	6.0	7.7	7.9	17.3
TWF.333/.392YW1	8.5	10.0	6.8	8.1	7.9	18.3
TWF.367/.418YW1	9.3	10.6	7.6	9.0	7.9	19.1
TWF.397/.447YW1	10.1	11.3	8.3	9.7	9.6	19.8
TWF.427/.475YW1	10.9	12.1	9.0	10.4	7.9	20.6
TWF.435/.509YW1	11.1	12.9	9.3	11.2	9.4	21.1
TWF.481/.547YW1	12.2	13.9	10.4	12.5	9.4	22.1
TWF.500/.563YW1	12.7	14.3	11.2	12.7	9.4	22.6
TWF.530/.615YW1	13.5	15.6	11.9	13.9	9.4	23.4
TWF.560/.631YW1	14.2	16.0	12.6	14.7	10.4	24.6
TWF.590/.667YW1	15.0	16.9	13.2	15.4	11.2	25.4
TWF.610/.687YW1	15.5	17.5	13.9	16.1	11.2	26.2
TWF.628/.725YW1	15.9	18.4	14.2	16.8	11.2	26.9
TWF.658/.750YW1	16.7	19.1	14.9	17.5	11.2	27.7
TWF.690/.775YW1	17.5	19.7	15.8	18.3	11.9	28.5
TWF.725/.812YW1	18.4	20.6	16.8	19.3	12.7	29.5
TWF.755/.870YW1	19.2	22.1	17.6	20.5	12.7	30.0
TWF.820/.930YW1	20.8	23.6	19.2	22.0	13.5	31.8
TWF.867/.975YW1	22.0	24.8	20.5	23.2	14.2	32.5
TWF.915/1.03YW1	23.2	26.3	21.3	24.4	16.0	34.0
TWF.984/1.10YW1	25.0	28.1	23.3	26.4	16.8	36.6
TWF1.09/1.21YW1	27.8	30.9	26.2	28.8	17.5	39.6
TWF1.11/1.23YW1	28.2	31.3	26.5	29.4	16.8	39.6
TWF1.15/1.28YW1	29.2	32.6	28.1	30.6	16.8	39.6



As a Guide for Part Selection, an Application Advisor is Available On Our Website.

## MOCAP Stocked Parts

We keep many varieties of our caps, plugs and grips in stock and ready to ship. All of our stock items are available in Box, Mini-Pack and Micro-Pack quantities and can be ordered online for faster turnaround.

[www.mocap.co.uk](http://www.mocap.co.uk)

# Tapered Caps & Plugs



## TWF Series (continued)

### Thick Wide Flange Tapered Plug Caps

- Thicker and Wider Flange for Added Durability
- High-Visibility Colour
- Material: Yellow Low-Density Polyethylene



Part #	(A) Small O.D.	(B) Large O.D.	(C) Small I.D.	(D) Large I.D.	(E) Length	(F) Flange O.D.
	mm	mm	mm	mm	mm	mm
TWF1.23/1.38YW1	31.4	35.1	29.6	32.7	16.8	42.7
TWF1.31/1.46YW1	33.3	37.2	31.7	34.6	20.6	46.7
TWF1.41/1.51YW1	36.0	38.5	34.4	37.1	17.5	44.5
TWF1.45/1.60YW1	36.9	40.7	35.0	38.2	16.0	49.3
TWF1.58/1.71YW1	40.1	43.5	38.5	41.9	16.0	52.3
TWF1.73/1.88YW1	43.9	47.9	41.9	45.2	16.0	58.7
TWF1.81/1.97YW1	46.0	50.2	43.9	48.1	16.0	60.4
TWF1.85/2.02YW1	47.0	51.3	45.4	48.7	25.4	62.0
TWF1.92/2.05YW1	49.0	52.3	47.2	50.5	16.0	60.4
TWF2.07/2.22YW1	52.8	56.6	51.2	54.2	25.2	66.8
TWF2.12/2.40YW1	54.0	61.1	52.4	59.5	25.4	68.3
TWF2.13/2.31YW1	54.3	58.7	52.7	57.2	25.4	69.9
TWF2.29/2.46YW1	58.4	62.6	56.8	60.2	25.4	73.2
TWF2.30/2.62YW1	58.6	66.6	57.0	65.0	31.8	77.7
TWF2.39/2.60YW1	60.8	66.1	59.3	63.5	28.7	76.2
TWF2.47/2.72YW1	62.9	69.2	61.1	67.3	23.1	80.3
TWF2.63/2.75YW1	67.0	70.1	65.2	67.6	17.5	81.8
TWF2.68/2.95YW1	68.2	75.1	66.6	74.1	25.4	87.4
TWF2.99/3.25YW1	76.0	82.6	74.2	80.0	25.4	95.3
TWF3.00/3.12YW1	76.3	79.5	74.7	77.3	19.1	90.4
TWF3.09/3.37YW1	78.5	85.6	76.7	84.4	25.4	96.8
TWF3.22/3.56YW1	81.9	90.5	80.1	89.3	28.5	101.6
TWF3.32/3.45YW1	84.5	87.8	82.4	85.9	19.1	98.6
TWF3.79/3.92YW1	96.3	99.6	94.2	97.5	19.1	110.2
TWF4.01/4.13YW1	101.9	105.0	100.0	103.2	19.1	117.4
TWF4.64/4.81YW1	117.9	122.3	116.1	119.0	22.3	131.3
TWF6.61/6.68YW1	167.9	169.8	165.9	168.4	36.3	180.9

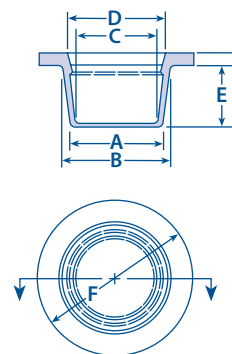

As a Guide for Part Selection, an Application Advisor is Available On Our Website.



### To use as a CAP:

Select a CAP with a "Small I.D." Dimension at least 0.5 mm smaller than the diameter to be capped (increase 1% or more for large diameters).

### To use as a PLUG:

Select a PLUG with a "Large O.D." Dimension at least 0.5 mm larger than the diameter to be plugged (increase 1% or more for large diameters).

# MOCAP

## Thick Wide Flange Tapered Plug Caps

Designed to Cap Multiple Outer Diameters or to Plug Multiple Inner Diameters

# Tapered Caps & Plugs



## XW Series

### Thick Extra-Wide Flange Tapered Plug Caps

- Featuring a Wider Flange than the TWF Series for Added Protection of External Surfaces
- Over-Sized Flanges and High-Visibility for Pre-Assembly Operation Removal
- Material: Yellow Low-Density Polyethylene



Part #	(A) Small O.D.	(B) Large O.D.	(C) Small I.D.	(D) Large I.D.	(E) Length	(F) Flange O.D.
	mm	mm	mm	mm	mm	mm
XW.628/.725YW1	16.0	18.4	14.4	16.3	11.2	56.6
XW.755/.870YW1	19.2	22.1	17.4	20.0	12.7	60.2
XW.867/.975YW1	22.0	24.8	20.3	22.6	14.2	63.0
XW.984/1.10YW1	25.0	28.1	23.1	25.8	16.8	66.3
XW1.11/1.25YW1	28.2	31.8	26.6	29.7	16.8	69.3
XW1.23/1.38YW1	31.4	35.1	29.7	32.8	16.8	73.2
XW1.31/1.46YW1	33.3	37.2	31.6	34.9	16.8	75.4
XW1.45/1.60YW1	36.9	40.7	35.2	38.6	16.8	78.7
XW1.58/1.71YW1	40.1	43.5	38.4	41.2	16.8	81.5
XW1.73/1.90YW1	44.1	48.3	42.5	46.7	18.3	101.6
XW1.92/2.05YW1	48.9	52.3	47.4	50.1	16.8	90.4
XW2.12/2.29YW1	53.8	58.2	51.7	56.1	25.4	96.3
XW2.39/2.60YW1	60.8	66.1	59.0	64.3	28.7	104.1
XW2.63/2.79YW1	67.0	71.0	64.7	67.8	28.7	108.2

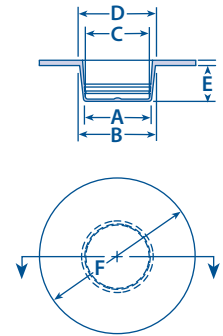

As a Guide for Part Selection, an Application Advisor is Available On Our Website.



## CPW Series

### Centre Pull Wide Flange Tapered Plugs

- Centre Pull Tab Allows for Quick & Easy Removal
- Featuring a Wider Flange than the CP Series for Added Protection of External Surfaces
- Material: Red Low-Density Polyethylene



Part #	(A) Small O.D.	(B) Large O.D.	(C) Flange O.D.	(D) Length	(E) Tab Height	(F) Tab Width
	mm	mm	mm	mm	mm	mm
CPW.48/.54RD1	12.2	13.7	31.8	13.5	6.4	9.5
CPW.59/.65RD1	15.0	16.4	26.9	12.7	6.4	9.5
CPW.73/.79RD1	18.5	20.1	38.1	12.7	6.4	15.9
CPW.75/.85RD1	19.1	21.6	33.3	12.7	6.4	15.9
CPW.92/1.08RD1	23.4	27.3	41.1	19.1	6.4	15.9
CPW.98/1.04RD1	24.9	26.4	47.8	13.5	6.4	15.9
CPW1.07/1.19RD1	27.2	30.2	43.9	17.5	6.4	25.4
CPW1.20/1.30RD1	30.5	32.9	47.8	19.1	6.4	25.4
CPW1.23/1.29RD1	31.2	32.8	50.8	12.7	6.4	25.4
CPW1.46/1.55RD1	37.1	39.4	60.5	19.1	6.4	25.4
CPW1.52/1.60RD1	38.6	40.7	57.2	19.1	6.4	25.4
CPW1.81/1.93RD1	45.9	49.1	64.3	19.1	6.4	25.4
CPW1.96/2.05RD1	49.8	52.1	69.9	19.1	6.4	25.4
CPW2.46/2.55RD1	62.5	64.8	82.6	19.1	6.4	25.4

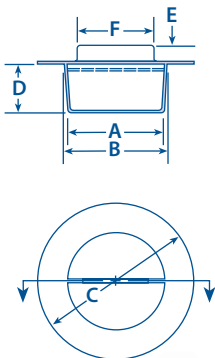

As a Guide for Part Selection, an Application Advisor is Available On Our Website as a Guideline.



# Tapered Caps & Plugs



## CP Series Centre Pull Tapered Plugs

- Centre Pull Tab Allows for Quick & Easy Removal
- Extra Strong Tab is Moulded into Plug so it Will Not Break Off
- Material: Red Low-Density Polyethylene



Part #	(A) Small O.D.	(B) Large O.D.	(C) Flange O.D.	(D) Length	(E) Tab Height	(F) Tab Width
	mm	mm	mm	mm	mm	mm
CP.11/.18RD1	2.9	4.6	7.9	9.6	9.6	3.1
CP.14/.20RD1	3.7	5.2	10.4	9.6	9.6	3.8
CP.23/.30RD1	6.0	7.7	11.2	9.6	9.6	6.1
CP.29/.36RD1	7.6	9.3	12.7	9.6	9.6	7.7
CP.33/.39RD1	8.4	10.1	13.5	9.6	9.6	6.4
CP.36/.42RD1	9.2	10.9	14.2	9.6	9.6	6.5
CP.41/.48RD1	10.6	12.3	16.0	9.6	9.6	8.0
CP.47/.54RD1	12.0	13.9	17.5	11.2	9.6	9.5
CP.53/.60RD1	13.5	15.4	19.1	11.2	7.9	10.0
CP.55/.63RD1	14.0	16.0	19.1	11.9	6.4	10.0
CP.64/.72RD1	16.3	18.5	22.3	12.7	6.4	12.0
CP.69/.78RD1	17.5	20.0	23.9	14.2	6.4	13.0
CP.75/.84RD1	19.1	21.5	25.4	14.2	6.4	13.0
CP.80/.91RD1	20.4	23.1	26.9	16.0	6.4	13.0
CP.91/1.04RD1	23.2	26.4	29.5	17.5	6.4	13.0
CP1.15/1.3RD1	29.2	33.0	36.3	19.1	6.4	21.0
CP1.17/1.28RD1	29.9	32.7	36.6	19.1	6.4	21.0
CP1.22/1.35RD1	31.1	34.4	38.1	19.1	6.4	21.0
CP1.23/1.36RD1	31.4	34.5	38.9	19.1	6.4	21.0
CP1.29/1.35RD1	32.8	34.4	38.1	19.8	6.4	21.0
CP1.31/1.46RD1	33.3	37.2	41.1	19.1	6.4	21.0
CP1.32/1.41RD1	33.7	36.0	41.9	14.0	3.8	25.4
CP1.34/1.52RD1	34.1	38.8	44.5	22.4	6.4	25.4
CP1.36/1.42RD1	34.5	36.1	43.7	13.5	3.8	25.4
CP1.45/1.60RD1	36.9	40.7	44.5	19.1	6.4	25.4
CP1.56/1.68RD1	39.7	42.8	48.5	19.1	6.4	25.4
CP1.63/1.75RD1	41.5	44.5	49.3	19.8	6.4	25.4
CP1.73/1.78RD1	44.1	45.3	49.3	12.7	3.8	25.4
CP1.76/1.81RD1	44.7	46.1	55.4	12.7	3.8	25.4
CP1.79/1.93RD1	45.6	49.2	54.9	25.4	6.4	25.4
CP1.82/1.83RD1	46.2	46.6	51.6	12.7	3.8	25.4
CP2.06/2.24RD1	52.5	57.0	62.0	26.2	6.4	25.4
CP2.23/2.27RD1	56.6	57.7	63.5	12.7	3.8	25.4
CP2.30/2.46RD1	58.4	62.6	67.6	25.4	6.4	25.4
CP2.42/2.63RD1	61.6	66.9	73.2	25.4	6.4	25.4
CP2.69/2.86RD1	68.5	72.8	75.4	12.7	3.8	25.4
CP2.85/2.98RD1	72.4	75.7	83.3	19.1	6.4	25.4
CP3.32/3.45RD1	84.3	87.7	91.9	19.1	6.4	25.4

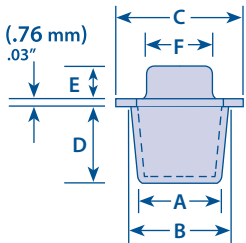
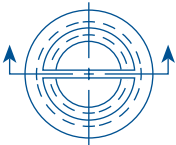

As a Guide for Part Selection, an Application Advisor is Available On Our Website.



# MOCAP

## Centre Pull Tapered Plugs

- Centre Pull Tab for Easy Removal
- Tapered Plastic Plug fits Multiple Size Openings



# Tapered Caps & Plugs



## MPTP Series Paper Tapered Plugs

- Sizes to Fit Female NPT Threads
- Environmentally Friendly & Economical Masking Solution
- Does Not Promote Condensation
- Withstands Up to 204°C (400°F) – Ideal for Low-To-High Temp Apps
- Material: Tan Recyclable Paper May Have Minor Dimensional Variation Due to Changes in Relative Humidity

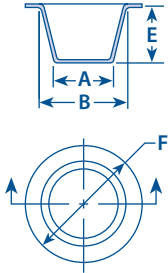

Part #	To Fit FEMALE NPT Thread	To Fit STD Thread	To Fit METRIC Thread	To Fit BSP Thread	(A) Small O.D.	(B) Large O.D.	(E) Length	(F) Flange O.D.
*see note for tolerance information					mm	mm	mm	mm
MPTP002	1/8	7/16	M10, M11	---	9.0	10.5	8.7	14.3
MPTP004	---	1/2	M11, M12	G1/4	9.4	11.9	9.1	16.0
MPTP006	1/4	9/16	M14	G1/4	11.7	12.8	9.2	17.4
MPTP008	---	5/8	M14, M15	---	11.9	14.6	10.6	19.3
MPTP009	3/8	11/16	M16, M17	G3/8	13.2	16.1	10.7	22.1
MPTP011	3/8	---	M16, M17, M18	G3/8	14.7	17.7	12.2	22.0
MPTP012	---	3/4, 13/16	M18, M20	G1/2	16.5	19.7	11.5	25.5
MPTP014	1/2	---	M20, M22	G1/2	17.2	20.8	13.5	26.3
MPTP016	---	7/8, 15/16	M22, M24	G5/8	19.8	22.3	14.8	30.0
MPTP017	3/4	15/16, 1	M24, M25, M26, M27	G3/4	21.8	24.1	17.5	32.9
MPTP019	3/4	1, 1-1/16	M25, M26, M27, M28, M30	G3/4	23.3	28.3	13.8	35.0
MPTP020	1	1-1/8, 1-3/16, 1-1/4	M27, M28, M30, M33	G7/8, G1	25.4	31.4	19.3	38.8
MPTP022	1	1-5/16, 1-3/8, 1-7/16, 1-1/2	M33, M35, M36	G1	29.8	36.5	16.1	44.0
MPTP023	---	1-1/2, 1-9/16, 1-5/8	M36, M38, M39, M40, M42	G1-1/4	34.6	40.7	14.6	47.8
MPTP027	1-1/4	1-11/16, 1-3/4, 1-13/16, 1-7/8	M42, M45, M48	G1-1/4, G1-1/2	38.0	45.1	17.5	53.8
MPTP029	1-1/2	1-13/16, 1-7/8, 1-15/16, 2	M48, M50	G1-1/2, G1-3/4	43.8	52.4	17.2	61.7
MPTP030	---	2-1/8, 2-1/4	M52, M55, M56	G1-3/4	47.6	56.1	17.8	68.6
MPTP031	---	2-1/4, 2-3/8	M56, M58, M60	G1-3/4, G2	50.2	58.4	26.1	74.2
MPTP032	2	2-3/8, 2-1/2	M60, M62, M63, M64, M65	G2	56.3	63.5	16.3	74.5
MPTP033	2-1/2	2-7/8, 3	M72, M75, M76, M78, M80	---	67.0	79.9	19.1	90.7
MPTP034	3	3-1/2	M90	---	83.2	91.4	18.7	103.9



## MPTC Series Paper Tapered Caps

- Sizes to Fit Male NPT Threads
- Environmentally Friendly & Economical Masking Solution
- Does Not Promote Condensation
- Withstands Up to 204°C (400°F) – Ideal for Low-To-High Temp Apps
- Material: Tan Recyclable Paper May Have Minor Dimensional Variation Due to Changes in Relative Humidity

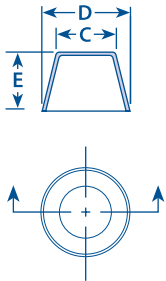

Part #	To Fit MALE NPT Thread	To Fit STD Thread	To Fit METRIC Thread	To Fit BSP Thread	(C) Small I.D.	(D) Large I.D.	(E) Inside Length
*see note for tolerance information					mm	mm	mm
MPTC002	1/8	3/8	M10	G1/8	9.0	10.1	10.1
MPTC003	1/4	1/2, 9/16, 5/8	M14, M15	---	11.9	12.4	13.5
MPTC004	---	1/2, 9/16, 5/8	M14, M15	G1/4, G3/8	12.3	19.0	22.4
MPTC006	3/8	3/4	M18	G3/8	16.5	16.5	13.1
MPTC007	1/2	13/16, 7/8	M20	G1/2	19.7	21.2	19.5
MPTC008	---	15/16, 1	M22, M24	G5/8	20.6	24.2	21.2
MPTC009	---	1	M25, M26	G5/8, G3/4	22.0	26.6	16.7
MPTC010	3/4	1, 1-1/16	M25, M26, M27	G3/4	24.1	27.3	22.5
MPTC011	---	1-3/16, 1-1/4	M30, M32	G7/8	28.6	33.0	18.2
MPTC012	1	---	M32	G1	32.2	32.0	25.3
MPTC013	---	1-7/16, 1-1/2	M35, M36, M38	---	33.3	38.6	17.8
MPTC014	---	1-1/2	M38, M39, M40	---	36.7	41.2	20.6
MPTC015	1-1/4	---	M42	G1-1/4	41.0	42.8	21.5
MPTC016	---	1-3/4, 1-13/16, 1-15/16, 2	M45, M48, M50	---	42.5	51.1	18.3
MPTC017	1-1/2	1-7/8	M48	G1-1/2, G2	46.4	48.0	23.9
MPTC018	2	---	M60	G2	59.1	59.5	22.0
MPTC019	---	2-5/8, 2-3/4	M68, M70, M72	---	65.7	72.3	24.9
MPTC020	2-1/2	---	M72	---	71.8	72.3	24.6
MPTC021	3	3-3/8, 3-1/2	M85, M90	---	84.2	92.2	28.3

NOTE: Part dimensions are typical from a measured lot. • Individual pieces may vary. • Due to the material, this product may have minor dimensional variation due to changes in relative humidity. • Flange concentricity may vary. • Due to paper's natural structure, the product may be oblong in free state. This will generally aid in the product's retention capability.

# Threaded Caps & Plugs



## BGC Series

### Threaded Caps for BSP/Gas Fittings

- Knurled Grip for Easy Application
- Material: Red Low-Density Polyethylene



Part #	To Fit BSP Thread	(B) Length	Rib Count
		mm	
BGC0125RD1	1/8-28	9.6	4
BGC0250RD1	1/4-19	11.0	4
BGC0375RD1	3/8-19	11.3	4
BGC0500RD1	1/2-14	13.5	6
BGC0625RD1	5/8-14	15.7	6
BGC0750RD1	3/4-14	17.7	6
BGC0875RD1	7/8-14	19.5	6
BGC1000RD1	1-11	19.2	6
BGC1250RD1	1-1/4-11	19.8	8
BGC1500RD1	1-1/2-11	20.5	8
BGC2000RD1	2-11	21.0	8
BGC2250RD1	2-1/4-11	25.0	8
BGC2500RD1	2-1/2-11	27.6	8

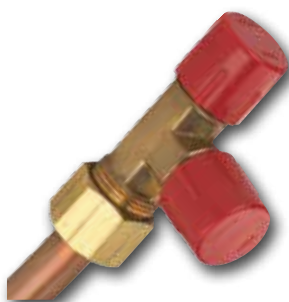
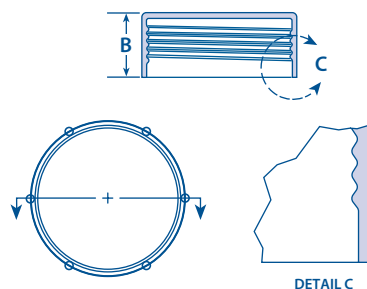

## CMT Series

### Threaded Caps for Metric Thread Fittings

- Knurled Grip for Easy Application
- Material: Red Low-Density Polyethylene



Part #	To Fit METRIC Thread	(B) Length	Rib Count
		mm	
CMT0810RD1	M8x1	10.0	4
CMT1010RD1	M10x1	10.0	4
CMT1210RD1	M12x1	12.0	6
CMT1215RD1	M12x1.5	12.0	6
CMT1415RD1	M14x1.5	12.0	6
CMT1415LRD1	M14x1.5	21.0	6
CMT1615RD1	M16x1.5	12.0	6
CMT1615LRD1	M16x1.5	21.0	6
CMT1815RD1	M18x1.5	14.0	6
CMT2015RD1	M20x1.5	14.0	6
CMT2215RD1	M22x1.5	13.8	6
CMT2215LRD1	M22x1.5	24.5	6
CMT2415RD1	M24x1.5	14.0	6
CMT2515RD1	M25x1.5	14.0	6
CMT2615RD1	M26x1.5	14.0	6
CMT2815RD1	M28x1.5	12.4	6
CMT3020RD1	M30x2	12.5	8
CMT3620RD1	M36x2	16.0	8
CMT4220RD1	M42x2	16.0	8
CMT5220RD1	M52x2	16.0	8

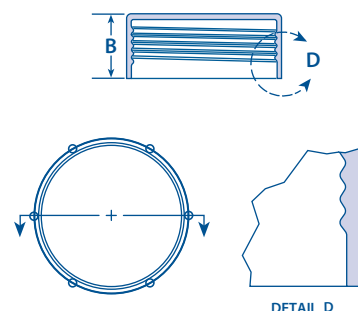

**Order Online**  
for fast turnaround!

**MOCAP FREE SAMPLES**

0800 856 2466

# Threaded Caps & Plugs



## FJC Series Threaded Caps for Flared JIC Fittings

- Knurled Grip for Easy Application
- Material: Red Low-Density Polyethylene

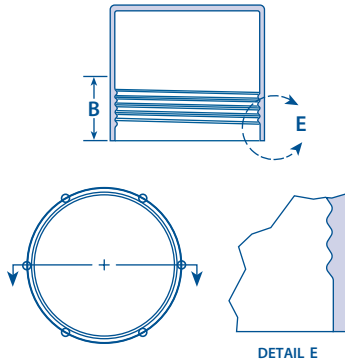

Part #	Tube Size mm	To Fit STD Thread	(B) Length mm	Rib Count
FJC110RD1	4.8	3/8-24	11.9	4
FJC140RD1	6.4	7/16-24	7.6	4
FJC120RD1	6.4	7/16-20	11.9	4
FJC150RD1	7.9	1/2-20	7.9	6
FJC130RD1	7.9	1/2-20	11.9	6
FJC160RD1	7.9	1/2-20	22.4	6
FJC180RD1	9.5	9/16-18	13.5	6
FJC210RD1	---	5/8-24	10.4	6
FJC170RD1	9.5	5/8-18	11.9	6
FJC190RD1	9.5	5/8-18	13.5	6
FJC200RD1	9.5	5/8-18	19.1	6
FJC260RD1	---	3/4-20	12.7	6
FJC230RD1	12.7	3/4-16	12.7	6
FJC220RD1	12.7	3/4-16	14.5	6
FJC240RD1	12.7	3/4-16	16.0	6
FJC250RD1	---	3/4-18	17.5	6
FJC280RD1	15.9	7/8-18	11.2	6
FJC270RD1	15.9	7/8-14	17.3	6
FJC300RD1	15.9	7/8-20	18.3	6
FJC290RD1	15.9	7/8-18	19.8	6
FJC310RD1	---	1-14	19.8	8
FJC320RD1	---	1-20	19.8	8
FJC330RD1	19.1	1-1/16-12	19.1	8
FJC340RD1	19.1	1-1/16-14	19.1	8
FJC350RD1	---	1-1/8-18	11.9	8
FJC360RD1	22.2	1-3/16-12	23.9	8
FJC370RD1	---	1-1/4-18	11.9	8
FJC380RD1	---	1-5/16-12	22.4	8
FJC390RD1	---	1-3/8-18	11.9	8
FJC400RD1	---	1-1/2-12	19.1	8
FJC410RD1	31.8	1-5/8-12	23.1	8
FJC420RD1	---	1-3/4-12	23.9	8
FJC430RD1	38.1	1-7/8-12	25.4	8

### MOCAP Stocked Parts

We keep many varieties of our caps, plugs and grips in stock and ready to ship. All of our stock items are available in Box, Mini-Pack and Micro-Pack quantities and can be ordered online for faster turnaround.

[www.mocap.co.uk](http://www.mocap.co.uk)

# MOCAP®

## Threaded Caps

with Knurled Grips for Easy Application

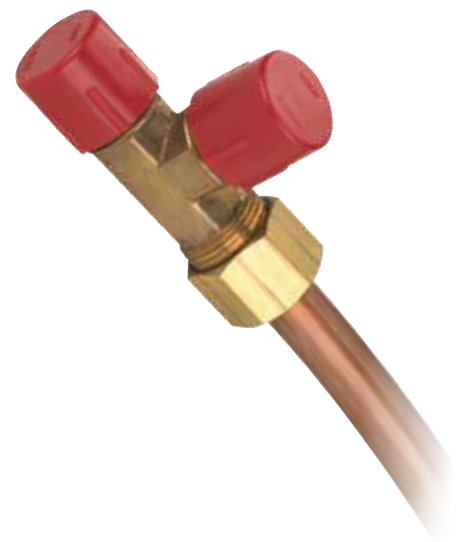

# Threaded Caps & Plugs



## SPU Series

### Sealing Plugs for Unified/Straight Threads

- Designed with Five Complete Threads Plus an Integrated Sealing Lip for a Tight Fit
- Also Available with a Factory Fit Neoprene O-Ring when a Secure Seal is Required
- Materials: Red Polypropylene or Yellow Nylon



Part #	O-Ring	To Fit STD Thread	(A) Flange O.D.	(B) Stem Height	Colour
			mm	mm	
SPU0437-20RD4	n/a	7/16-20	20.8	8.9	RED
SPU0437-20RD4NO	included	7/16-20	20.8	8.9	RED
SPU0500-20RD4	n/a	1/2-20	22.9	9.9	RED
SPU0500-20RD4NO	included	1/2-20	22.9	9.9	RED
SPU0562-18RD4	n/a	9/16-18	24.9	9.9	RED
SPU0562-18RD4NO	included	9/16-18	24.9	9.9	RED
SPU0625-18RD4	n/a	5/8-18	24.9	11.9	RED
SPU0625-18RD4NO	included	5/8-18	24.9	11.9	RED
SPU0750-16RD4	n/a	3/4-16	25.9	13.0	RED
SPU0750-16RD4NO	included	3/4-16	25.9	13.0	RED
SPU0875-14RD4	n/a	7/8-14	33.8	11.9	RED
SPU0875-14RD4NO	included	7/8-14	33.8	11.9	RED
SPU1062-12RD4	n/a	1-1/16-12	40.9	11.9	RED
SPU1062-12RD4NO	included	1-1/16-12	40.9	11.9	RED
SPU1313-12RD4	n/a	1-5/16-12	41.9	15.0	RED
SPU1313-12RD4NO	included	1-5/16-12	41.9	15.0	RED
SPU1625-12RD4	n/a	1-5/8-12	57.9	15.0	RED
SPU1625-12RD4NO	included	1-5/8-12	57.9	15.0	RED
SPU0437-20YW5	n/a	7/16-20	20.8	8.9	YELLOW
SPU0437-20YW5NO	included	7/16-20	20.8	8.9	YELLOW
SPU0500-20YW5	n/a	1/2-20	22.9	9.9	YELLOW
SPU0500-20YW5NO	included	1/2-20	22.9	9.9	YELLOW
SPU0562-18YW5	n/a	9/16-18	24.9	9.9	YELLOW
SPU0562-18YW5NO	included	9/16-18	24.9	9.9	YELLOW
SPU0625-18YW5	n/a	5/8-18	24.9	11.9	YELLOW
SPU0625-18YW5NO	included	5/8-18	24.9	11.9	YELLOW
SPU0750-16YW5	n/a	3/4-16	25.9	13.0	YELLOW
SPU0750-16YW5NO	included	3/4-16	25.9	13.0	YELLOW
SPU0875-14YW5	n/a	7/8-14	33.8	11.9	YELLOW
SPU0875-14YW5NO	included	7/8-14	33.8	11.9	YELLOW
SPU1062-12YW5	n/a	1-1/16-12	40.9	11.9	YELLOW
SPU1062-12YW5NO	included	1-1/16-12	40.9	11.9	YELLOW
SPU1313-12YW5	n/a	1-5/16-12	41.9	15.0	YELLOW
SPU1313-12YW5NO	included	1-5/16-12	41.9	15.0	YELLOW
SPU1625-12YW5	n/a	1-5/8-12	57.9	15.0	YELLOW
SPU1625-12YW5NO	included	1-5/8-12	57.9	15.0	YELLOW

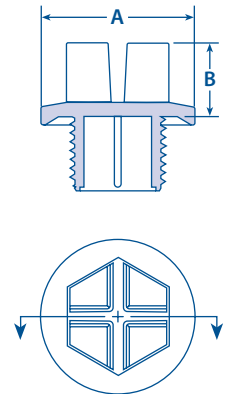

For More Information, Please Contact Sales on

**0800 856 2466**

# Threaded Caps & Plugs



## SPM Series Sealing Plugs for Metric Threads

- Designed with Five Complete Threads Plus an Integrated Sealing Lip for a Tight Fit
- Also Available with a Factory Fit Neoprene O-Ring when a Secure Seal is Required
- Materials: Red Polypropylene or Yellow Nylon

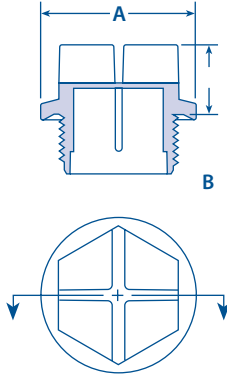

Part #	O-Ring	To Fit METRIC Thread	(A) Flange O.D.	(B) Stem Height	Colour
			mm	mm	
SPM1010RD4	n/a	M10 x 1.0	14.2	9.9	RED
SPM1010RD4NO	included	M10 x 1.0	14.2	9.9	RED
SPM1215RD4	n/a	M12 x 1.5	17.3	9.9	RED
SPM1215RD4NO	included	M12 x 1.5	17.3	9.9	RED
SPM1415RD4	n/a	M14 x 1.5	19.3	9.9	RED
SPM1415RD4NO	included	M14 x 1.5	19.3	9.9	RED
SPM1615RD4	n/a	M16 x 1.5	22.1	9.9	RED
SPM1615RD4NO	included	M16 x 1.5	22.1	9.9	RED
SPM1815RD4	n/a	M18 x 1.5	23.9	10.9	RED
SPM1815RD4NO	included	M18 x 1.5	23.9	10.9	RED
SPM2015RD4	n/a	M20 x 1.5	25.9	14.0	RED
SPM2015RD4NO	included	M20 x 1.5	25.9	14.0	RED
SPM2215RD4	n/a	M22 x 1.5	27.2	14.0	RED
SPM2215RD4NO	included	M22 x 1.5	27.2	14.0	RED
SPM2415RD4	n/a	M24 x 1.5	31.5	14.0	RED
SPM2415RD4NO	included	M24 x 1.5	31.5	14.0	RED
SPM2615RD4	n/a	M26 x 1.5	32.0	14.0	RED
SPM2615RD4NO	included	M26 x 1.5	32.0	14.0	RED
SPM2720RD4	n/a	M27 x 2.0	32.3	14.0	RED
SPM2720RD4NO	included	M27 x 2.0	32.3	14.0	RED
SPM3320RD4	n/a	M33 x 2.0	40.4	14.0	RED
SPM3320RD4NO	included	M33 x 2.0	40.4	14.0	RED
SPM1010YW5	n/a	M10 x 1.0	14.2	9.9	YELLOW
SPM1010YW5NO	included	M10 x 1.0	14.2	9.9	YELLOW
SPM1215YW5	n/a	M12 x 1.5	17.3	9.9	YELLOW
SPM1215YW5NO	included	M12 x 1.5	17.3	9.9	YELLOW
SPM1415YW5	n/a	M14 x 1.5	19.3	9.9	YELLOW
SPM1415YW5NO	included	M14 x 1.5	19.3	9.9	YELLOW
SPM1615YW5	n/a	M16 x 1.5	22.1	9.9	YELLOW
SPM1615YW5NO	included	M16 x 1.5	22.1	9.9	YELLOW
SPM1815YW5	n/a	M18 x 1.5	23.9	10.9	YELLOW
SPM1815YW5NO	included	M18 x 1.5	23.9	10.9	YELLOW
SPM2015YW5	n/a	M20 x 1.5	25.9	14.0	YELLOW
SPM2015YW5NO	included	M20 x 1.5	25.9	14.0	YELLOW
SPM2215YW5	n/a	M22 x 1.5	27.2	14.0	YELLOW
SPM2215YW5NO	included	M22 x 1.5	27.2	14.0	YELLOW
SPM2415YW5	n/a	M24 x 1.5	31.5	14.0	YELLOW
SPM2415YW5NO	included	M24 x 1.5	31.5	14.0	YELLOW
SPM2615YW5	n/a	M26 x 1.5	32.0	14.0	YELLOW
SPM2615YW5NO	included	M26 x 1.5	32.0	14.0	YELLOW
SPM2720YW5	n/a	M27 x 2.0	32.3	14.0	YELLOW
SPM2720YW5NO	included	M27 x 2.0	32.3	14.0	YELLOW
SPM3320YW5	n/a	M33 x 2.0	40.4	14.0	YELLOW
SPM3320YW5NO	included	M33 x 2.0	40.4	14.0	YELLOW

### MOCAP Stocked Parts

We keep many varieties of our caps, plugs and grips in stock and ready to ship. All of our stock items are available in Box, Mini-Pack and Micro-Pack quantities and can be ordered online for faster turnaround.

[www.mocap.co.uk](http://www.mocap.co.uk)

# Threaded Caps & Plugs



## SPB Series Sealing Plugs for BSP Threads

- Designed with Five Complete Threads Plus an Integrated Sealing Lip for a Tight Fit
- Also Available with a Factory Fit Neoprene O-Ring when a Secure Seal is Required
- Materials: Red Polypropylene or Yellow Nylon



Part #	O-Ring	To Fit BSP Thread	(A) Flange O.D.	(B) Stem Height	Colour
			mm	mm	
SPB0250RD4	n/a	G 1/4	19.3	9.9	RED
SPB0250RD4NO	included	G 1/4	19.3	9.9	RED
SPB0375RD4	n/a	G 3/8	22.1	10.9	RED
SPB0375RD4NO	included	G 3/8	22.1	10.9	RED
SPB0500RD4	n/a	G 1/2	27.2	12.9	RED
SPB0500RD4NO	included	G 1/2	27.2	12.9	RED
SPB0750RD4	n/a	G 3/4	32.3	12.9	RED
SPB0750RD4NO	included	G 3/4	32.3	12.9	RED
SPB1000RD4	n/a	G 1	39.9	14.0	RED
SPB1000RD4NO	included	G 1	39.9	14.0	RED
SPB1250RD4	n/a	G 1-1/4	50.3	15.0	RED
SPB1250RD4NO	included	G 1-1/4	50.3	15.0	RED
SPB1500RD4	n/a	G 1-1/2	55.4	15.0	RED
SPB1500RD4NO	included	G 1-1/2	55.4	15.0	RED
SPB2000RD4	n/a	G 2	68.3	15.0	RED
SPB2000RD4NO	included	G 2	68.3	15.0	RED
SPB0250YW5	n/a	G 1/4	19.3	9.9	YELLOW
SPB0250YW5NO	included	G 1/4	19.3	9.9	YELLOW
SPB0375YW5	n/a	G 3/8	22.1	10.9	YELLOW
SPB0375YW5NO	included	G 3/8	22.1	10.9	YELLOW
SPB0500YW5	n/a	G 1/2	27.2	12.9	YELLOW
SPB0500YW5NO	included	G 1/2	27.2	12.9	YELLOW
SPB0750YW5	n/a	G 3/4	32.3	12.9	YELLOW
SPB0750YW5NO	included	G 3/4	32.3	12.9	YELLOW
SPB1000YW5	n/a	G 1	39.9	14.0	YELLOW
SPB1000YW5NO	included	G 1	39.9	14.0	YELLOW
SPB1250YW5	n/a	G 1-1/4	50.3	15.0	YELLOW
SPB1250YW5NO	included	G 1-1/4	50.3	15.0	YELLOW
SPB1500YW5	n/a	G 1-1/2	55.4	15.0	YELLOW
SPB1500YW5NO	included	G 1-1/2	55.4	15.0	YELLOW
SPB2000YW5	n/a	G 2	68.3	15.0	YELLOW
SPB2000YW5NO	included	G 2	68.3	15.0	YELLOW

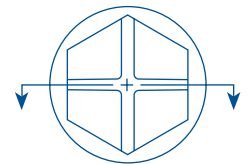
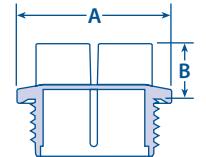

## MOCAP<sup>®</sup> Sealing Plugs

- Moulded in Red Polypropylene (Standard Applications) or
- Yellow Nylon (Offers High Resistance Against Hydraulic Fluids, Solvents, Acids and Base Alkalines)
- Sizes to Fit Standard, Metric and BSP Threads



# Threaded Caps & Plugs



## FJP Series

### Threaded Plugs for Flared JIC Fittings

- Designed for Flared JIC Fittings & to Seal 37° Flare Fittings without Gaskets
- Knurled Grip for Easy On-Off Application
- Material: Red Low-Density Polyethylene



Part #	Tube Size	To Fit STD Thread	(B) Length	(C) Flange O.D.	(D) Flange Thickness
	mm				
FJP20RD1	3.2	5/16-24	11.2	11.2	4.6
FJP30RD1	4.8	3/8-24	11.7	12.7	4.6
FJP40RD1	6.4	7/16-20	13.5	15.7	4.8
FJP50RD1	7.9	1/2-20	13.5	17.3	6.4
FJP60RD1	9.5	9/16-18	12.7	20.6	6.4
FJP65RD1	---	5/8-18	15.0	20.6	6.4
FJP80RD1	12.7	3/4-16	19.1	23.9	6.4
FJP100RD1	15.9	7/8-14	22.1	26.9	6.4
FJP110RD1	19.1	1-1/16-12	21.8	35.8	6.4
FJP140RD1	19.1	1-1/16-14	21.8	35.8	6.4
FJP120RD1	19.1	1-1/16-14	28.4	33.3	6.4
FJP150RD1	22.2	1-3/16-12	23.6	38.1	6.4
FJP160RD1	25.4	1-5/16-12	23.6	38.1	6.4
FJP180RD1	---	1-1/2-12	23.6	44.5	6.4
FJP190RD1	31.8	1-5/8-12	23.9	56.4	8.6
FJP200RD1	---	1-3/4-12	24.6	58.7	8.6
FJP280RD1	38.1	1-7/8-12	26.9	62.7	9.7
FJP240RD1	38.1	1-7/8-12	29.2	58.7	7.9
FJP300RD1	44.5	2-1/4-12	33.3	69.9	9.7
FJP320RD1	50.8	2-1/2-12	33.3	78.5	9.7

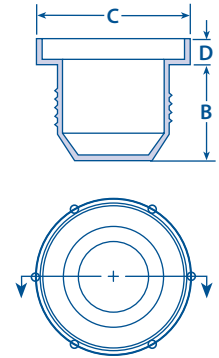

## IFP Series

### Threaded Plugs for Inverted Flared Fittings

- Knurled Grip for Easy On-Off Application & Can be Used to Seal Boss-Type Fittings without Gaskets
- Material: Red Low-Density Polyethylene



Part #	To Fit STD Thread	(B) Length	(C) Flange O.D.	(D) Flange Thickness
		mm	mm	mm
IFP300RD1	5/16-28	5.6	11.2	4.8
IFP310RD1	3/8-24	6.4	12.7	4.8
IFP320RD1	7/16-24	6.9	16.0	4.8
IFP330RD1	1/2-20	7.1	17.5	6.4
IFP340RD1	5/8-18	7.9	20.6	6.4
IFP350RD1	5/8-18	12.7	20.6	6.4
IFP360RD1	11/16-18	7.9	22.1	6.4
IFP370RD1	3/4-18	9.7	22.1	6.4
IFP380RD1	1-1/16-16	10.9	30.2	6.4

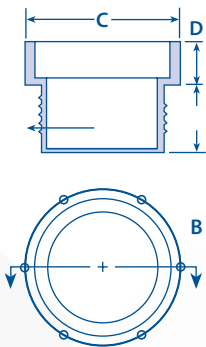

For More Information, Please Contact Sales on

**0800 856 2466**



# Threaded Caps & Plugs



## TNP Series

### Plugs for MS-21921 Flareless Tube and Nut Assemblies

- Designed to Fit MS-21921 Tube & Nut Assemblies Interchangeably
- Knurled Grip for Easy Application & Provide a Better-Than-Normal Seal with Only Hand-Tightening
- Material: Red Low-Density Polyethylene

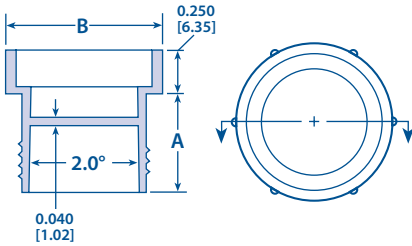

Part #	To Fit STD Thread	(A) Length		(B) Flange O.D.	
		mm	mm	mm	mm
TNP0375RD1	3/8-24	8.9	12.7	12.7	12.7
TNP0438RD1	7/16-20	10.2	14.2	14.2	14.2
TNP0500RD1	1/2-20	11.7	16.0	16.0	16.0
TNP0562RD1	9/16-18	12.2	17.3	17.3	17.3
TNP0750RD1	3/4-16	13.7	22.1	22.1	22.1
TNP0875RD1	7/8-14	15.7	25.4	25.4	25.4
TNP1063RD1	1-1/16-12	16.3	31.8	31.8	31.8
TNP1313RD1	1-5/16-12	18.3	38.1	38.1	38.1



## FOP Series

### Threaded Plugs for Flat Faced O-Ring Fittings

- Knurled Head for Easy Use in Manual Assembly and Removal
- Material: Red Low-Density Polyethylene



Part #	To Fit STD Thread	Tube Size		(A) Length		(B) Flange O.D.	
		mm	mm	mm	mm	mm	mm
FOP200RD1	11/16-16	9.5	11.2	11.2	22.1	22.1	22.1
FOP210RD1	13/16-16	12.7	12.7	12.7	23.9	23.9	23.9
FOP220RD1	1-14	15.9	15.0	15.0	29.5	29.5	29.5
FOP230RD1	1-3/16-12	19.1	16.0	16.0	33.8	33.8	33.8
FOP240RD1	1-7/16-12	25.4	19.1	19.1	41.4	41.4	41.4

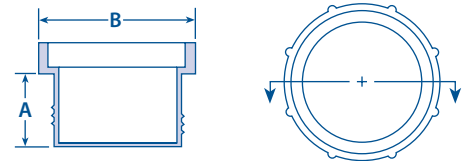

## MOCAP Stocked Parts

We keep many varieties of our caps, plugs and grips in stock and ready to ship. All of our stock items are available in Box, Mini-Pack and Micro-Pack quantities and can be ordered online for faster turnaround.

[www.mocap.co.uk](http://www.mocap.co.uk)

# Threaded Caps & Plugs



## GPB Series

### General Purpose Plugs for BSP Threads

- Designed to Protect BSP Threads and Fittings from Damage, Dust, Debris and Contaminants
- Knurled Head and Slot for Easy On-Off Application
- Material: Red Polypropylene

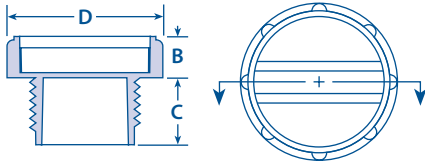
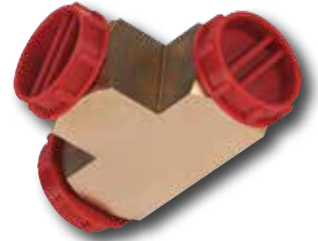

Part #	To Fit BSP Thread	(B) Flange Thick- ness	(C) Length	(D) Flange O.D.
		mm	mm	mm
GPB0125RD4	G 1/8	5.1	8.9	21.1
GPB0250RD4	G 1/4	5.1	8.9	21.1
GPB0375RD4	G 3/8	6.1	9.9	23.1
GPB0500RD4	G 1/2	6.1	11.9	27.9
GPB0625RD4	G 5/8	6.1	11.9	30.5
GPB0750RD4	G 3/4	6.1	14.0	34.3
GPB0875RD4	G 7/8	7.62	14.0	38.1
GPB1000RD4	G 1	7.62	14.0	40.6
GPB1250RD4	G 1-1/4	7.62	14.0	50.8
GPB1500RD4	G 1-1/2	8.9	15.0	54.6
GPB2000RD4	G2	8.9	15.0	66.9
GPB3000RD4	G3	10.2	19.1	94.7



## GPM Series

### General Purpose Plugs for Metric Threads

- Designed to Protect Metric Threads and Fittings from Damage, Dust, Debris and Contaminants
- Knurled Head and Slot for Easy On-Off Application
- Material: Red Polypropylene



Part #	To Fit METRIC Thread	(B) Flange Thickness	(C) Length	(D) Flange O.D.
		mm	mm	mm
GPM0810RD4	M8x1.0	5.1	8.9	16.5
GPM1010RD4	M10x1.0	5.1	8.9	16.5
GPM1210RD4	M12x1.0	5.1	8.9	21.1
GPM1215RD4	M12x1.5	5.1	8.9	21.1
GPM1415RD4	M14x1.5	5.1	8.9	21.1
GPM1615RD4	M16x1.5	6.1	9.9	23.1
GPM1815RD4	M18x1.5	6.1	9.9	23.1
GPM2015RD4	M20x1.5	6.1	11.9	27.9
GPM2215RD4	M22x1.5	6.1	11.9	27.9
GPM2415RD4	M24x1.5	6.1	11.9	31.0
GPM2515RD4	M25x1.5	6.1	11.9	31.0
GPM2615RD4	M26x1.5	6.1	11.9	33.0
GPM5220RD4	M52x2.0	8.9	15.0	61.0

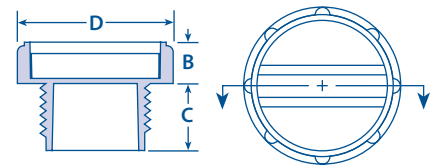

## MOCAP Stocked Parts

We keep many varieties of our caps, plugs and grips in stock and ready to ship. All of our stock items are available in Box, Mini-Pack and Micro-Pack quantities and can be ordered online for faster turnaround.

[www.mocap.co.uk](http://www.mocap.co.uk)



# Threaded Caps & Plugs



## SFPN Series

### Square Head Flanged Plugs for NPT Threads

- Flange Allows for Protection of the Outside of Port
- Designed to Protect Threads from Dirt, Dust & Moisture During Low-Pressure Testing & In-Plant Handling
- Material: Red Polypropylene



Part #	To Fit NPT Thread	(B) Stem Height	(C) Threaded Area Length	(D) Flange O.D.	(E) Head
		mm	mm	mm	mm
SFPN0125RD4	1/8-27	4.8	7.4	14.0	7.1
SFPN0250RD4	1/4-18	6.4	8.9	17.0	10.9
SFPN0375RD4	3/8-18	6.4	10.4	20.3	10.9
SFPN0500RD4	1/2-14	6.4	11.9	24.9	14.2
SFPN0750RD4	3/4-14	6.4	13.2	31.5	15.7

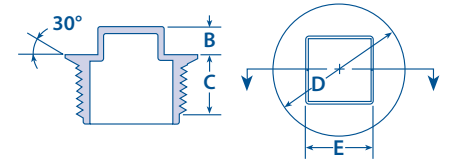

## SPN Series

### Square Head Plugs for NPT Threads

- Designed to Protect Threads from Dirt, Dust & Moisture During Low-Pressure Testing & In-Plant Handling
- Material: Red Polypropylene



Part #	To Fit NPT Thread	(B) Stem Height	(C) Threaded Area Length	(D) Length	(E) Head
		mm	mm	mm	mm
SPN0125RD4	1/8-27	6.4	7.4	9.4	7.1
SPN0250RD4	1/4-18	6.4	8.9	10.9	9.7
SPN0375RD4	3/8-18	6.4	10.7	12.4	11.2
SPN0500RD4	1/2-14	6.4	11.9	14.0	14.2
SPN0750RD4	3/4-14	6.4	13.2	16.3	15.7
SPN1000RD4	1 - 11-1/2	6.4	15.0	17.8	20.6
SPN1250RD4	1-1/4 - 11-1/2	9.7	21.1	24.9	25.4
SPN1500RD4	1-1/2 - 11-1/2	9.7	21.1	24.9	31.8

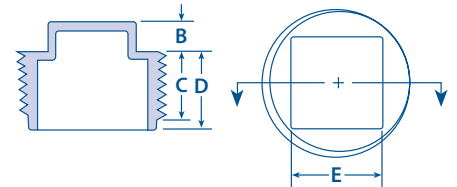

## HSPN Series

### Hex Socket Plugs for NPT Threads

- Designed to Protect Threads from Dirt, Dust & Moisture During Low-Pressure Testing & In-Plant Handling
- Material: Red Polypropylene

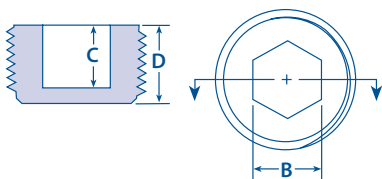

Part #	To Fit NPT Thread	(B) Inside Diameter	(C) Inside Length	(D) Length
		mm	mm	mm
HSPN0250RD4	1/4-18	6.6	7.9	12.7
HSPN0375RD4	3/8-18	8.4	9.7	14.4
HSPN0500RD4	1/2-14	9.9	9.7	14.4
HSPN0750RD4	3/4-14	14.5	11.9	15.5
HSPN1000RD4	1 - 11-1/2	16.3	15.0	18.8

# Threaded Caps & Plugs



## GPU Series

### General Purpose Plugs for Unified/Straight Threads

- Designed to Provide Positive Seal on SAE Straight-Thread Ports
- Features a Moulded-In O-Ring Style Bead & External Lip on the Flange to Seal Out Contaminants
- Material: Red Polypropylene

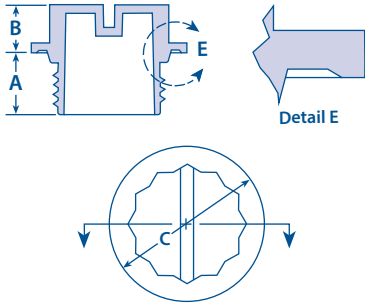

Part #	To Fit STD Thread	(A) Length	(B) Stem Height	(C) Flange O.D.
		mm	mm	mm
GPU0437-20RD4	7/16-20	8.6	5.3	16.8
GPU0437-24RD4	7/16-24	8.6	5.3	16.8
GPU0500-20RD4	1/2-20	8.6	6.4	18.5
GPU0562-18RD4	9/16-18	9.1	6.4	20.3
GPU0625-18RD4	5/8-18	9.1	6.4	22.1
GPU0750-16RD4	3/4-16	10.4	6.4	25.9
GPU0875-14RD4	7/8-14	13.5	6.4	29.5
GPU-1000-14RD4	1-14	13.5	6.4	34.9
GPU1062-12RD4	1-1/16-12	15.5	6.4	36.8
GPU1187-12RD4	1-3/16-12	15.5	6.4	40.6
GPU1313-12RD4	1-5/16-12	15.5	6.4	44.2
GPU1625-12RD4	1-5/8-12	15.5	6.4	55.1
GPU1875-12RD4	1-7/8-12	15.5	6.4	61.9



## OPP Series

### Threaded Plugs for Straight Thread O-Ring Ports

- Provides a Positive Seal on SAE Straight-Thread O-Ring Type Ports and Mil-MS-33649 Bosses
- Features Moulded-In O-Ring Style Bead on the Outside of Head to Seal the Port Face from Oil Leakage
- Material: Red Polypropylene



Part #	To Fit STD Thread	(B) Length	(C) Flange O.D.	(E) Flange Thickness
		mm	mm	mm
OPP0438RD4	7/16-20	8.1	16.5	9.6
OPP0500RD4	1/2-20	8.1	18.3	9.6
OPP0562RD4	9/16-18	9.1	19.8	9.6
OPP0750RD4	3/4-16	10.2	24.9	9.6
OPP0875RD4	7/8-14	11.4	28.2	9.6
OPP1062RD4	1-1/16-12	15.7	33.3	9.6
OPP1312RD4	1-5/16-12	15.7	39.6	9.6
OPP1625RD4	1-5/8-12	15.7	47.8	9.6

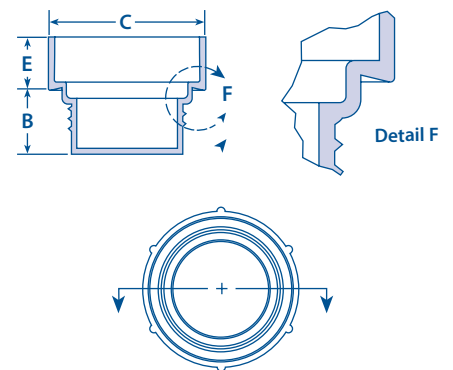

## MOCAP Stocked Parts

We keep many varieties of our caps, plugs and grips in stock and ready to ship. All of our stock items are available in Box, Mini-Pack and Micro-Pack quantities and can be ordered online for faster turnaround.

[www.mocap.co.uk](http://www.mocap.co.uk)



# Threaded Caps & Plugs



## PIP Series Push-In Plugs for SAE & NPT Threads

- Designed to Simply Snap into Place to Protect Threads
- Material: Red Low-Density Polyethylene



Part #	To Fit NPT Thread	To Fit SAE Thread	(A) Diameter	(B) Length	(C) Flange O.D.
			mm	mm	mm
PIP0250RD1	---	1/4"	5.2	5.6	11.5
PIP0313RD1	---	5/16"	6.7	6.0	13.4
PIPL0375RD1	1/8"	3/8"	7.9	8.6	14.9
PIP0375RD1	1/8"	3/8"	8.2	6.0	14.9
PIP0438RD1	---	7/16"	9.7	6.9	16.7
PIP0500RD1	1/4"	1/2"	11.1	6.9	18.4
PIPL0563RD1	---	9/16"	12.2	9.1	21.2
PIP0563RD1	---	9/16"	12.6	7.4	20.6
PIP0625RD1	3/8"	5/8"	14.2	7.4	24.7
PIP0688RD1	---	11/16"	15.5	7.4	25.6
PIP0750RD1	---	3/4"	17.2	7.4	26.5
PIP0813RD1	1/2"	13/16"	18.6	7.4	27.8
PIP0875RD1	---	7/8"	20.3	7.5	29.8
PIP1000RD1	3/4"	1"	23.4	7.4	33.1
PIP1062RD1	---	1-1/16"	24.7	7.4	36.0
PIP1188RD1	---	1-3/16"	27.7	8.6	38.6
PIP1250RD1	---	1-1/4"	29.5	8.6	39.9
PIP1313RD1	1"	1-5/16"	30.9	8.6	41.7
PIP1438RD1	---	1-7/16"	34.5	11.7	45.8
PIP1500RD1	---	1-1/2"	35.7	11.7	47.1
PIP1625RD1	---	1-5/8"	38.7	11.7	50.3
PIP1750RD1	---	1-3/4"	41.9	11.7	53.8
PIP1875RD1	---	1-7/8"	45.1	11.7	56.3

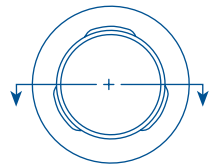
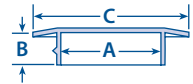

## U Series Universal Thread Plugs

- Designed for Maximum Flexibility to Fit Many Different Thread Types & Sizes with a Simple Push-In & Turn to Lock-In-Place
- Material: Red Low-Density Polyethylene



Part #	To Fit ...	(B) Length	(C) Bevel Length	(D) Stem Diameter
		mm	mm	mm
U100RD1	1/8" NPT, 7/16" UNF, 1/8" BSP, M10	13.5	6.6	11.0
U105RD1	1/2" UNF, 1/4" BSP, M11-12	14.2	7.1	12.8
U110RD1	1/4" NPT, 9/16" UNF, 1/4" BSP, M14	15.0	7.9	14.4
U115RD1	3/4" UNF, 3/8" BSP, M16-20	17.0	9.9	19.7
U120RD1	1" UNF, 1/2" - 5/8" BSP, M22-25	18.8	11.7	24.8
U125RD1	3/4" NPT, 1-3/16" UN, 3/4"-7/8" BSP, M30	23.1	14.2	30.9
U130RD1	1-7/16" UN, 7/8"-1" BSP, M36	24.9	14.2	37.6

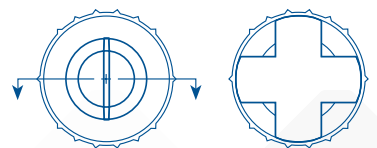
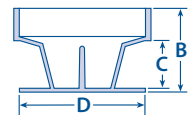

For More Information, Please Contact Sales on  
**0800 856 2466**

# Grips



## B Series Round Vinyl Grips

- Flexible Yet Durable - Won't Split, Tear or Shred
- Printable
- Material: Black Vinyl Additional Colours: ○●●●●●●●●●●

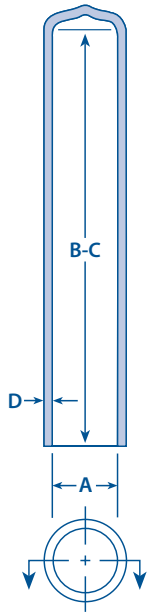

Part #	(A) Inside Diameter mm	(B) Min Inside Length mm	(C) Max Inside Length mm	(D) Wall Thickness mm	Stocked Length mm
B4.8GS	4.8	50.9	127	1.7	---
B6.0GS	6.0	50.9	127	1.7	---
B6.4GS	6.4	50.9	152.4	1.7	---
B7.1GS	7.1	50.9	152.4	1.7	---
B7.5GS	7.5	50.9	140.0	1.7	---
B8.0GS	8	50.9	120.0	1.7	120.0
B8.7GS	8.7	50.9	101.6	1.7	---
B9.5GS	9.5	50.9	225.0	1.7	127.0
B10.3GS	10.3	50.9	90.0	1.7	---
B11.1GS	11.1	50.9	125.0	1.7	---
B11.9GS	11.9	50.9	152.4	1.7	127.0
B12.7GS	12.7	50.9	152.4	1.7	---
B14.3GS	14.3	50.9	152.4	1.7	---
B15.9GS	15.9	50.9	152.4	1.7	125.0
B17.5GS	17.5	50.9	125.0	1.7	---
B19.0GS	19.0	50.9	152.4	1.7	127.0
B20.6GS	20.6	50.9	152.4	1.7	---
B21.4GS	21.4	50.9	152.4	1.7	127.0
B22.2GS	22.2	50.9	152.4	1.7	---
B23.8GS	23.8	50.9	152.4	1.7	---
B24.6GS	24.6	50.9	250.0	1.7	127.0
B25.4GS	25.4	50.9	152.4	1.7	---
B27.0GS	27.0	50.9	60.0	1.7	---
B28.6GS	28.6	50.9	130.0	1.7	---
B30.2GS	30.2	50.9	300.0	1.7	---
B31.8GS	31.8	50.9	152.4	1.7	---
B34.9GS	34.9	50.9	100.0	1.7	---
B38.1GS	38.1	50.9	60.2	1.7	---
B39.7GS	39.7	50.9	60.2	1.7	---
B41.3GS	41.3	50.9	60.2	1.7	---
B42.0GS	42.0	50.9	100.0	1.7	---
B42.9GS	42.9	50.9	60.2	1.7	---
B44.5GS	44.5	50.9	80.0	1.7	---
B47.6GS	47.6	50.9	60.2	1.7	---
B48.5GS	48.5	50.9	70.0	1.7	---
B50.8GS	50.8	50.9	101.6	1.7	---
B54.0GS	54.0	50.9	101.6	1.7	---
B55.0GS	55.0	50.9	100	1.7	---
B57.2GS	57.2	50.9	100	1.7	---
B60.3GS	60.3	50.9	60.2	1.7	---
B63.5GS	63.5	50.9	60.2	1.7	---
B69.9GS	69.9	50.9	70.0	1.7	---
B76.2GS	76.2	50.9	60.2	2.0	---
B77.0GS	77.0	50.9	90.0	2.0	---
B80.0GS	80.0	50.9	110	2.0	---
B92.0GS	92.0	50.9	90.0	2.0	---
B95.3GS	95.3	50.9	75.0	2.0	---
B101.6GS	101.6	50.9	152.4	2.0	---
B114.3GS	114.3	50.9	80.0	2.0	---
B117.5GS	117.5	50.9	80.0	2.0	---

## **MOCAP** Vinyl Grips

- Tough, Weather Resistant and Attractive
- Many Colours Available
- Glossy or Textured Materials

### **MOCAP** Stocked Parts

We keep many varieties of our caps, plugs and grips in stock and ready to ship. All of our stock items are available in Box, Mini-Pack and Micro-Pack quantities and can be ordered online for faster turnaround.

[www.mocap.co.uk](http://www.mocap.co.uk)



## F Series Flat Rectangular Vinyl Grips

- Grips Feature either a Round End or a Flat End
- Flexible Yet Durable - Won't Split, Tear or Shred
- Printable
- Material: Black Vinyl Additional Colours: ○○●●●●●●●●



Part #	(A) Inside Height	(B) Inside Width	(C) End Style	(D) Min Inside Length	(E) Max Inside Length	(F) Wall Thickness
	mm	mm		mm	mm	mm
F1.6S6.5	1.6	6.5	Flat	4.8	18.0	1.5
F1.6S7.3	1.6	7.3	Round	4.8	20.0	1.5
F1.6S8.0	1.6	8.0	Round	4.8	115.0	1.5
F1.6S9.5	1.6	9.5	Flat	4.8	101.6	1.5
F1.6S11.1	1.6	11.1	Round	4.8	101.6	1.5
F1.6S12.7	1.6	12.7	Flat	4.8	76.2	1.5
F1.6S15.9	1.6	15.9	Round	4.8	127.0	1.5
F1.6S19.0	1.6	19.0	Round	4.8	152.4	1.5
F1.6S21.0	1.6	21.0	Flat	4.8	38.1	1.5
F1.6S23.0	1.6	23.0	Flat	4.8	90.0	1.5
F1.6S36.5	1.6	36.5	Flat	4.8	152.4	1.5
F2.3S25.4	2.3	25.4	Flat	4.8	152.4	1.5
F3.0S18.0	3.0	18.0	Round	4.8	112.0	1.5
F3.0S32.0	3.0	32.0	Round	4.8	127.0	1.5
F3.0S38.0	3.0	38.0	Round	4.8	110.0	1.5
F3.0S50.8	3.0	50.8	Round	4.8	152.4	1.5
F3.0S70.0	3.0	70.0	Flat	4.8	110.0	1.5
F3.2S11.1	3.2	11.1	Round	4.8	76.2	1.5
F3.2S12.7	3.2	12.7	Round	4.8	152.4	1.5
F3.2S14.3	3.2	14.3	Flat	4.8	90.0	1.5
F3.2S15.9	3.2	15.9	Round	4.8	76.2	1.5
F3.2S19.0	3.2	19.0	Round	4.8	152.4	1.5
F3.2S22.2	3.2	22.2	Round	4.8	230.0	1.5
F3.2S25.4	3.2	25.4	Round	4.8	152.4	1.5
F3.2S26.9	3.2	26.9	Flat	4.8	152.4	1.5
F3.2S27.0	3.2	27.0	Round	4.8	152.4	1.5
F3.2S31.8	3.2	31.8	Round	4.8	60.5	1.5
F3.2S34.0	3.2	34.0	Flat	4.8	120.0	1.5
F3.3S34.0	3.3	34.0	Flat	4.8	152.4	1.5
F4.0S34.9	4.0	34.9	Round	4.8	152.4	1.5
F4.0S80.0	4.0	80.0	Flat	4.8	101.6	1.5
F4.0S100.0	4.0	100	Round	4.8	101.6	1.5
F4.8S35.0	4.8	35.0	Flat	4.8	127.0	1.5
F4.9S24.0	4.9	24.0	Flat	4.8	101.6	1.5
F5.0S21.0	5.0	21.0	Flat	4.8	152.4	1.5
F5.0S23.0	5.0	23.0	Flat	4.8	125.0	1.5
F5.0S25.0	5.0	25.0	Round	4.8	125.0	1.5
F5.0S45.0	5.0	45.0	Round	4.8	50.8	1.5
F5.0S58.0	5.0	58.0	Flat	4.8	30.0	1.5
F6.0S19.0	6.0	19.0	Round	4.8	152.4	1.5
F6.0S38.1	6.0	38.1	Round	4.8	152.4	1.5
F6.0S49.0	6.0	49.0	Round	4.8	160.0	1.5
F6.4S19.0	6.4	19.0	Round	4.8	50.8	1.5
F6.4S25.4	6.4	25.4	Round	4.8	152.4	1.5
F6.4S32.0	6.4	32.0	Flat	4.8	152.4	1.5
F6.4S38.1	6.4	38.1	Flat	4.8	125.0	1.5
F6.4S50.8	6.4	50.8	Flat	4.8	90.0	1.5
F8.0S20.0	8.0	20.0	Flat	4.8	70.0	1.5
F8.0S24.0	8.0	24.0	Flat	4.8	170.0	1.5
F8.0S25.0	8.0	25.0	Flat	4.8	110.0	1.5
F8.0S29.0	8.0	29.0	Flat	4.8	120.0	1.5
F8.0S38.1	8.0	38.1	Round	4.8	152.4	1.5
F10.0S29.0	10.0	29.0	Flat	4.8	152.4	1.5
F10.0S40.0	10.0	40.0	Flat	4.8	135.0	1.5
F12.7S63.5	12.7	63.5	Flat	4.8	80.0	1.5
F30.0S95.0	30.0	95.0	Flat	4.8	50.8	1.5

### Round End Grips

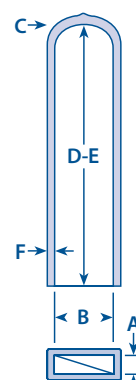

Inside Length Measured at Centre for Round End Only

### Flat End Grips

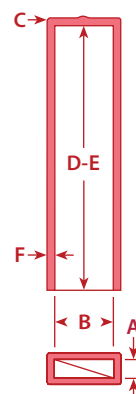





# Pipe & Flange Protection

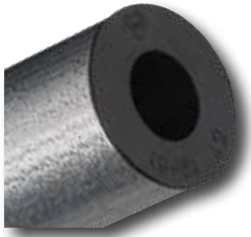

## PP Series Pipe Plugs

- Designed to Protect BSP and NPT Pipe from Damage and Contamination
- Material: Black Low-Density Polyethylene



Part #	To Fit Pipe O.D.	To Fit BSP	To Fit NPT
		in	in
PP114BK1	21.3	1/2	1/2
PP116BK1	25.4	---	---
PP117BK1	26.7	3/4	3/4
PP121BK1	33.4	1	1
PP124BK1	38.1	1-1/8	---
PP126BK1	42.0	1-1/4	1-1/4
PP128BK1	48.3	1-1/2	1-1/2
PP129BK1	50.0	---	---
PP134BK1	57.0	---	---
PP135BK1	60.3	2	2
PP137BK1	63.5	---	---
PP140BK1	73.0	---	2-1/2
PP141BK1	76.3	2-1/2	---
PP144BK1	88.9	3	3
PP147BK1	101.6	---	3-1/2
PP149BK1	108.0	---	---
PP150BK1	114.0	4	4
PP151BK1	121.0	---	---
PP152BK1	127.0	4-1/2	---
PP154BK1	133.0	---	---
PP156BK1	141.3	---	---
PP157BK1	152.0	5-1/2	---
PP159BK1	159.0	---	---
PP161BK1	168.3	6	6
PP162BK1	177.8	---	---

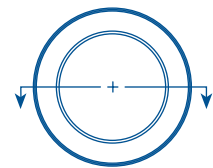

## MOCAP<sup>®</sup> Pipe Plugs

- Designed for Maximum Flexibility
- Designed to Secure BSP and NPT Threads from Damage and Contamination
- Easy to Install and Remove



### MOCAP Stocked Parts

We keep many varieties of our caps, plugs and grips in stock and ready to ship. All of our stock items are available in Box, Mini-Pack and Micro-Pack quantities and can be ordered online for faster turnaround.

[www.mocap.co.uk](http://www.mocap.co.uk)

# Pipe & Flange Protection



## PC Series Pipe Caps

- Designed to Protect Metric, BSP and NPT Male Pipe Threads from Damage and Contamination
- Material: Black Low-Density Polyethylene

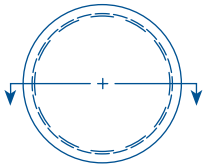
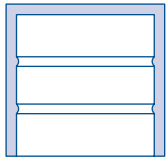

Part #	To Fit Pipe O.D.	To Fit BSP Threads	
		To Fit BSP Threads in	To Fit NPT Threads in
PC100BK1	8.0mm	---	---
PC102BK1	10.3mm	G 1/8	---
PC103BK1	12.0mm	---	---
PC104BK1	12.7mm	---	---
PC105BK1	13.7mm	G 1/4	1/4
PC107BK1	15.0mm	---	---
PC108BK1	16.0mm	---	---
PC109BK1	17.1mm	G 3/8	3/8
PC110BK1	18.0mm	---	---
PC112BK1	20.0mm	---	---
PC114BK1	21.3mm	G 1/2	1/2
PC115BK1	22.0mm	---	---
PC116BK1	25.4mm	---	---
PC117BK1	26.7mm	G 3/4	3/4
PC118BK1	28.0mm	---	---
PC119BK1	30.0mm	---	---
PC120BK1	31.8mm	---	---
PC121BK1	33.4mm	G 1	1
PC123BK1	35.0mm	---	---
PC124BK1	38.1mm	G 1-1/8	---
PC125BK1	40.0mm	---	---
PC126BK1	42.0mm	G 1-1/4	1-1/4
PC127BK1	45.0mm	G 1-3/8	---
PC128BK1	48.3mm	G 1-1/2	1-1/2
PC129BK1	50.0mm	---	---
PC130BK1	50.8mm	---	---
PC133BK1	54.0mm	G 1-3/4	---
PC134BK1	57.0mm	---	---
PC135BK1	60.3mm	G 2	2
PC137BK1	63.5mm	---	---
PC139BK1	70.0mm	---	---



### **MOCAP** Stocked Parts

We keep many varieties of our caps, plugs and grips in stock and ready to ship. All of our stock items are available in Box, Mini-Pack and Micro-Pack quantities and can be ordered online for faster turnaround.

[www.mocap.co.uk](http://www.mocap.co.uk)

# Pipe & Flange Protection



## PC Series *(continued)* Pipe Caps

- Designed to Protect Metric, BSP and NPT Male Pipe Threads from Damage and Contamination
- Material: Black Low-Density Polyethylene



Part #	To Fit Pipe O.D.	To Fit BSP Threads	To Fit NPT Threads
		in	in
PC140BK1	73.0mm	---	2-1/2
PC141BK1	76.3mm	G 2-1/2	---
PC142BK1	82.0mm	G 2-3/4	---
PC143BK1	85.0mm	---	---
PC144BK1	88.9mm	G 3	3
PC146BK1	95.0mm	---	---
PC147BK1	101.6mm	---	3-1/2
PC149BK1	108.0mm	---	---
PC150BK1	114.0mm	G 4	4
PC151BK1	121.0mm	---	---
PC152BK1	127.0mm	G 4-1/2	---
PC153BK1	129.0mm	---	---
PC154BK1	133.0mm	---	---
PC155BK1	139.7mm	G 5	5
PC157BK1	152.0mm	G 5-1/2	---
PC159BK1	159.0mm	---	---
PC161BK1	168.3mm	G 6	6
PC167BK1	219.0mm	G 8	8
PC173BK1	273.0mm	G 10	10
PC178BK1	323.9mm	G 12	12
PC182BK1	355.6mm	G 14	14
PC186BK1	406.4mm	G 16	16
PC188BK1	457.2mm	G 18	18
PC190BK1	508.0mm	G 20	20
PC192BK1	558.0mm	G 22	22
PC193BK1	610.0mm	G 24	24
PC195BK1	660.4mm	G 26	26
PC196BK1	711.2mm	G 28	28
PC197BK1	762.0mm	G 30	30
PC198BK1	812.8mm	G 32	32
PC200BK1	914.4mm	G 36	36
PC201BK1	1016.0mm	G 40	40

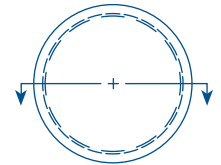
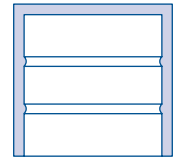

For More Information, Please Contact Sales on

**0800 856 2466**

# Pipe & Flange Protection



## MPI Series Push-In Flange Protectors

- Flexible Rings Allow for Easy Installation
- Designed to Protect Flange Faces from Damage and Contamination
- Material: Yellow Low-Density Polyethylene

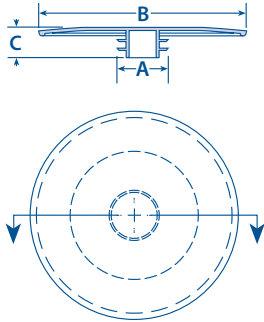

Part #	To Fit Nominal Pipe Size	DIN Flange Size	(A) Diameter	(B) Flange O.D.	(C) Length
	in		mm	mm	mm
MPI500YW1	1/2	DN 15	19.0	90.0	15.0
MPI750YW1	3/4	DN 20	24.0	100.0	15.0
MPI1000YW1	1	DN 25	30.0	110.0	20.0
MPI1250YW1	1-1/4	DN 32	39.0	136.0	20.0
MPI1500YW1	1-1/2	DN 40	45.0	146.0	20.0
MPI2000YW1	2	DN 50	56.0	160.0	20.0
MPI2500YW1	2-1/2	DN 65	72.0	180.0	20.0
MPI3000YW1	3	DN 80	85.0	196.0	25.0
MPI4000YW1	4	DN 100	109.0	216.0	25.0
MPI5000YW1	5	DN 125	134.0	246.0	25.0
MPI6000YW1	6	DN 150	161.0	280.0	35.0
MPI8000YW1	8	DN 200	210.0	336.0	35.0
MPI10000YW1	10	DN 250	262.0	390.0	40.0
MPI12000YW1	12	DN 300	318.0	450.0	48.0



## MOF Series Outside Fitting Flange Protectors

- Designed to Easily Snap Over the Full Face of the Flange for Maximum Protection
- Material: Yellow Low-Density Polyethylene

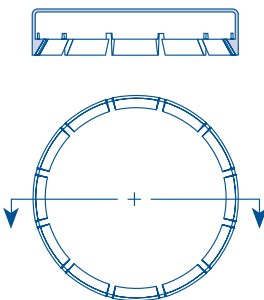

Part #	To Fit Nominal Pipe Size	DIN	Pipe Pressure Rating	PN
	in			
MOF150500YW1	1/2	DN 15	#150	20
MOF300500YW1	1/2	DN 15	#300 - #600	50, 100
MOF150750YW1	3/4	DN 20	#150	20
MOF1501000YW1	1	DN 25	#150	20
MOF3001000YW1	1	DN 25	#300 - #600	50, 100
MOF1501500YW1	1-1/2	DN 40	#150	20
MOF1502000YW1	2	DN 50	#150	20
MOF3002000YW1	2	DN 50	#300	50
MOF1503000YW1	3	DN 80	#150	20
MOF1504000YW1	4	DN 100	#150	20
MOF1506000YW1	6	DN 150	#150	20
MOF15010000YW1	10	DN 250	#150	20

For More Information, Please Contact Sales on

**0800 856 2466**

# Pipe & Flange Protection



## MBH Series Bolt Hole Flange Protectors

- Designed to Snap-In Easily Without Additional Fasteners
- Material: Blue or Black Low-Density Polyethylene - Stocked in One Colour, Blue or Black, per Pipe Pressure Rating



Part #	To Fit Nominal Pipe Size	Pipe Pressure Rating	Colour
	in		
MBH150500MB1	1/2	#125 - #150	BLUE
MBH150750MB1	3/4	#125 - #150	BLUE
MBH1501000MB1	1	#125 - #150	BLUE
MBH1501250MB1	1-1/4	#125 - #150	BLUE
MBH1501500MB1	1-1/2	#125 - #150	BLUE
MBH1502000MB1	2	#125 - #150	BLUE
MBH1502500MB1	2-1/2	#125 - #150	BLUE
MBH1503000MB1	3	#125 - #150	BLUE
MBH1504000MB1	4	#125 - #150	BLUE
MBH1505000MB1	5	#125 - #150	BLUE
MBH1506000MB1	6	#125 - #150	BLUE
MBH1508000MB1	8	#125 - #150	BLUE
MBH15010000MB1	10	#125 - #150	BLUE
MBH15012000MB1	12	#125 - #150	BLUE
MBH300500BK1	1/2	#300 - #400 - #600	BLACK
MBH300750BK1	3/4	#300 - #400 - #600	BLACK
MBH3001000BK1	1	#300 - #400 - #600	BLACK
MBH3001250BK1	1-1/4	#300 - #400 - #600	BLACK
MBH3001500BK1	1-1/2	#300 - #400 - #600	BLACK
MBH3002000BK1	2	#300 - #400 - #600	BLACK
MBH3002500BK1	2-1/2	#300 - #400 - #600	BLACK
MBH3003000BK1	3	#300 - #400 - #600	BLACK
MBH3004000BK1	4	#300	BLACK
MBH3005000BK1	5	#300	BLACK
MBH3006000BK1	6	#300	BLACK
MBH3008000BK1	8	#300	BLACK
MBH30010000BK1	10	#300	BLACK
MBH30012000BK1	12	#300	BLACK

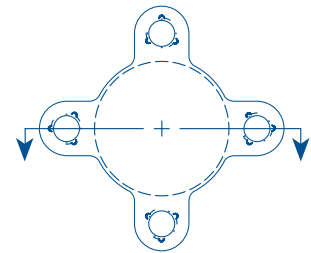
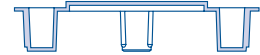

## **MOCAP** Bolt Hole Flange Protectors

- Easy Installation and Removal
- Designed to Protect Flanges From Damage and Contamination

# Masking



## H Series High-Temp Round Vinyl Caps

- Sizes to Fit Straight, Metric, BSP & NPT Threads and Fittings
- Withstands Up to 230°C (446°F)
- Flexible Yet Durable - Won't Split, Tear or Shred
- Material: Black Vinyl Additional Colours: ●●

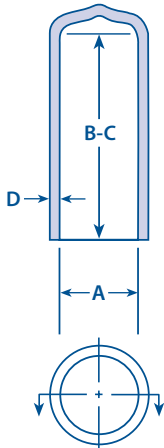

Part #	To Fit	To Fit	To Fit	(A) Inside	(B) Min Inside	(C) Max Inside	(D) Wall
	STD Thread	METRIC Thread	NPT Thread	Diameter	Length	Length	Thickness
				mm	mm	mm	mm
A1.6H	1	---	---	1.6	4.8	19	0.7
A1.8H	1 or 2	---	---	1.8	4.8	16	0.7
A2.0H	2 or 3	---	---	2	4.8	20	0.7
A2.4H	3 or 4	---	---	2.4	4.8	25.4	0.7
A2.8H	4 or 5	---	---	2.8	4.8	25.4	1.2
A3.0H	4 or 5	---	---	3	4.8	25.4	1.2
A3.2H	5 or 6	---	---	3.2	4.8	38.1	1.2
A3.5H	---	M4	---	3.5	4.8	38.1	1.2
A3.8H	---	M4	---	3.8	4.8	38.1	1.2
A4.0H	8	M4	---	4	4.8	38.1	1.4
A4.4H	10	M5	---	4.4	4.8	50.8	1.4
A4.8H	---	M5	---	4.8	4.8	50.8	1.4
A4.9H	---	M5	---	4.9	4.8	38.1	1.4
A5.3H	12	---	---	5.3	4.8	38.1	1.4
A5.8H	1/4 - 20	M6	---	5.8	4.8	38.1	1.4
A6.0H	1/4 - 20	M6	---	6	4.8	50.8	1.4
A6.4H	1/4 - 20	---	---	6.4	4.8	50.8	1.4
A7.0H	1/4 - 20	---	---	7	4.8	38.1	1.4
A7.1H	---	---	---	7.1	4.8	50.8	1.4
A7.5H	5/16 - 24	M8	---	7.5	4.8	50.8	1.4
A7.8H	5/16 - 24	M8	---	7.8	4.8	50.8	1.4
A8.0H	---	---	---	8	4.8	50.8	1.4
A8.7H	---	---	---	8.7	4.8	50.8	1.4
A9.3H	3/8 - 24	---	---	9.3	4.8	50.8	1.4
A9.5H	3/8 - 24	M10	---	9.5	4.8	50.8	1.4
A9.9H	---	M10	1/8	9.9	4.8	50.8	1.4
A10.3H	7/16 - 20	---	1/8	10.3	4.8	50.8	1.4
A11.1H	7/16 - 20	M12	---	11.1	4.8	50.8	1.4
A11.9H	1/2 - 20	M12	---	11.9	4.8	50.8	1.4
A12.7H	---	---	1/4	12.7	4.8	50.8	1.4
A13.5H	9/16 - 18	M14	1/4	13.5	4.8	50.8	1.4
A14.3H	9/16 - 18	---	---	14.3	4.8	50.8	1.4
A15.5H	5/8 - 18	M16	---	15.5	4.8	50.8	1.5
A15.9H	11/16 - 16	M16	3/8	15.9	4.8	50.8	1.5
A17.5H	3/4 - 16	M18	---	17.5	4.8	50.8	1.5
A19.0H	13/16 - 16	M20	---	19	4.8	50.8	1.5
A20.6H	13/16 - 16	---	1/2	20.6	4.8	50.8	1.5
A21.4H	7/8 - 14	M22	---	21.4	4.8	50.8	1.5
A22.2H	7/8 - 14	---	---	22.2	4.8	50.8	1.5
A23.8H	1 - 16	M24	---	23.8	4.8	50.8	1.5
A24.6H	1 - 16	M25	---	24.6	4.8	50.8	1.5

**Low-Temperature Applications**  
see page 1



For More Information, Please Contact Sales on

**0800 856 2466**



## H Series (continued) High-Temp Round Vinyl Caps

- Sizes to Fit Straight, Metric, BSP & NPT Threads and Fittings
- Withstands Up to 230°C (446°F)
- Flexible Yet Durable - Won't Split, Tear or Shred
- Material: Black Vinyl Additional Colours: ●●



Part #	To Fit STD Thread	To Fit METRIC Thread	To Fit NPT Thread	(A) Inside Diameter	(B) Min Inside Length	(C) Max Inside Length	(D) Wall Thickness
				mm	mm	mm	mm
A25.4H	1-1/16 12	M26	3/4	25.4	6.4	50.8	1.5
A27.0H	1-1/16 12	M27		27.0	6.4	50.8	1.5
A28.6H	1-3/16 12	M30		28.6	6.4	50.8	1.5
A30.2H	1-3/16 12	---		30.2	6.4	50.8	1.5
A31.8H	1-5/16 12	M32	1	31.8	6.4	50.8	1.5
A33.4H	1-5/16 12	M35	1	33.4	6.4	38.1	1.5
A34.9H	1-7/16 12	M35 M36		34.9	6.4	50.8	1.5
A36.1H	---	M37		36.1	6.4	50.8	1.5
A37.2H	---	M38		37.2	6.4	50.8	1.5
A38.1H	1-5/8 12	M39 M40		38.1	6.4	50.8	1.5
A39.7H	1-11/16 12	---	1 - 1/4	39.7	6.4	50.8	1.5
A41.3H	1-11/16 12	M42	1 - 1/4	41.3	6.4	50.8	1.5
A42.0H	1-11/16 12	M42	1 - 1/4	42.0	6.4	50.8	1.5
A42.9H	1-11/16 12	---	1 - 1/4	42.9	6.4	50.8	1.5
A44.5H	---	M45		44.5	6.4	50.8	1.5
A47.6H	1-7/8 12	M48	1 - 1/2	47.6	6.4	50.8	1.5
A48.5H	---	---		48.5	6.4	50.8	1.5
A49.0H	---	M49 M50		49.0	6.4	50.8	1.5
A50.8H	2	M52		50.8	6.4	50.8	1.5
A52.7H	---	M53 M54		52.7	6.4	50.8	1.5
A54.0H	---	---		54.0	6.4	50.8	1.5
A55.0H	---	---		55.0	6.4	50.8	1.5
A57.2H	2-1/4 12	M58 M60	2	57.2	6.4	50.8	1.5
A60.3H	2-1/2 12	---	2	60.3	6.4	50.8	1.5
A63.5H	2-1/2 12	M64		63.5	6.4	50.8	1.5
A66.7H	---	M68		66.7	6.4	36.0	1.5
A69.9H	---	M72	2 - 1/2	69.9	6.4	50.8	1.5
A76.2H	---	M80		76.2	6.4	50.8	2
A77.0H	---	---		77.0	6.4	50.8	2
A80.0H	---	---		80.0	6.4	50.8	2
A82.6H	---	---		82.6	6.4	50.8	2
A89.0H	---	M90	3	89.0	6.4	50.8	2
A92.0H	---	---		92.0	6.4	50.8	2
A95.3H	---	---		95.3	6.4	50.8	2
A101.6H	---	M105	3 - 1/2	101.6	6.4	50.8	2
A114.3H	---	M115	4	114.3	6.4	50.8	2
A117.5H	---	M120		117.5	6.4	50.8	2
A120.0H	---	---		120.0	6.4	50.8	2
A127.5H	---	---		127.5	6.4	50.8	2
A152.0H	---	---		152.0	6.4	50.8	2
A162.0H	---	---		162.0	6.4	50.8	2
A200.0H	---	---		200.0	6.4	50.8	2
A214.0H	---	---		214.0	6.4	50.8	2

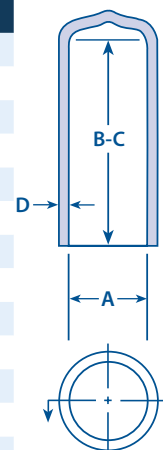

Maximum Temperature Specifications on page 66.

# Masking



## P Series High-Temp Pull Tab Vinyl Caps

- Withstands Up to 230°C (446°F)
- Stretches for a Snug Fit but Won't Split, Tear or Shred
- Flat / Ergonomic Tab for Easy Removal
- Material: Black Vinyl Additional Colours: ●●

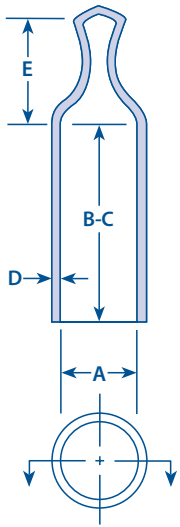

Part #	(A) Inside Diameter mm	(B) Min Inside Length mm	(C) Max Inside Length mm	(D) Wall Thickness mm	(E) Tab Height mm
D4.8FPTH	4.8	6.4	25.4	1.4	12.7
D5.5FPTH	5.5	6.4	25.4	1.4	12.7
D6.0FPTH	6.0	6.4	25.4	1.4	12.7
D6.4FPTH	6.4	6.4	25.4	1.4	12.7
D8.0FPTH	8.0	6.4	38.1	1.4	16.6
D8.7FPTH	8.7	6.4	38.1	1.4	17.7
D9.5FPTH	9.5	6.4	38.1	1.4	17.7
D10.3FPTH	10.3	6.4	38.1	1.4	18.0
D11.1FPTH	11.1	6.4	38.1	1.4	18.4
D11.7FPTH	11.7	6.4	38.1	1.4	19.1
D12.7FPTH	12.7	6.4	38.1	1.5	19.1
D13.5FPTH	13.5	6.4	38.1	1.5	19.4
D14.3FPTH	14.3	6.4	38.1	1.5	15.6
D15.9FPTH	15.9	6.4	38.1	1.5	18.0
D16.6FPTH	16.6	6.4	38.1	1.5	20.6
D17.5FPTH	17.4	6.4	38.1	1.5	20.6
D19.0FPTH	19.0	6.4	38.1	1.5	21.0
D20.6FPTH	20.6	6.4	50.8	1.5	21.3
D21.4FPTH	21.4	6.4	38.1	1.5	21.5
D22.2FPTH	22.2	6.4	38.1	1.5	21.5
D23.8FPTH	23.8	6.4	38.1	1.5	21.7
D25.4FPTH	25.4	6.4	38.1	1.5	21.8
D27.0FPTH	27.0	6.4	38.1	1.5	21.8
D28.6FPTH	28.6	6.4	50.8	1.5	21.8
D31.8FPTH	31.8	6.4	50.8	1.5	21.8

**Low-Temperature Applications**  
see page 4



For **Maximum Temperature Specifications**, please see page 66.



## MOCAP®

### High-Temp Pull Tab Vinyl Caps

- Masking Product Good to 246°C
- Disposable and Inexpensive
- Easy Application and Removal







## CMCP Series High-Temp Vinyl Insertion Plugs

- Withstands Up to 230°C (446°F)
- Wide Flange for Easy Removal
- Flexible Yet Durable - Won't Split, Tear or Shred
- Material: Black Vinyl Additional Colours: ●●



Part #	To Fit METRIC Thread	To Fit STD Thread	To Fit NPT Thread	(A) Flange O.D.
				mm
CMCP05H	M6	1/4	---	10.2
CMCP1H	M8	5/16	---	11.7
CMCP2H	M10	3/8	1/8	12.6
CMCP25H	M12	7/16	---	14.0
CMCP3H	M14	1/2	1/4	15.7
CMCP35H	M16	9/16	---	17.3
CMCP4H	M18	5/8	3/8	20.5
CMCP5H	M20	3/4	1/2	24.4
CMCP55H	M22/24	7/8	---	26.9
CMCP6H	M26/28	1-1/16	3/4	31.6
CMCP7H	M32/34	1-1/8, 1-3/16, 1-1/4	1	38.0

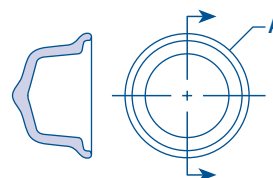

**Low-Temperature Applications**  
see page 5



## NTP Series High-Temp Vinyl Tapered Plugs

- Withstands Up to 246°C (446°F)
- Flange for Easy Removal
- Flexible Yet Durable - Won't Split, Tear or Shred
- Material: Black Vinyl Additional Colours: ●●

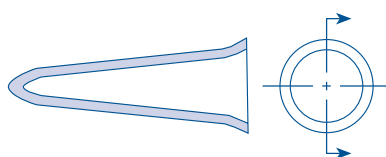

Part #	To Fit STD Thread	To Fit METRIC Thread
NTP1HB	6-32, 8-32, 10-24	M4, M5
NTP2HB	1/4 - 20	M6, M7
NTP3HB	5/16 - 18, 3/8 - 16	M8, M10



## MOCAP Stocked Parts

We keep many varieties of our caps, plugs and grips in stock and ready to ship. All of our stock items are available in Box, Mini-Pack and Micro-Pack quantities and can be ordered online for faster turnaround.

[www.mocap.co.uk](http://www.mocap.co.uk)

# Masking



## RMSC Series Silicone Straight Caps

- Resists Temps to 302°C (575°F)
- Flexible for Masking Threaded and Smooth Studs
- Material: Iron Oxide Orange Silicone

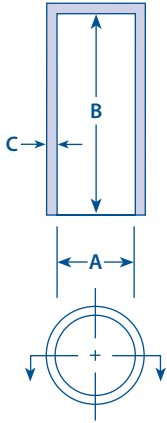

Part #	Suggested Applications	(A) Inside Diameter	(B) Inside Length	(C) Wall Thickness
		mm	mm	mm
RMSC070-1.00	M2 2-56	1.8	25.4	1.7
RMSC100-1.00	M3 4-40	2.5	25.4	1.3
RMSC120-1.00	6-32 1/8" tube	3.0	25.4	1.3
RMSC148-1.00	M4 8-32	3.8	25.4	1.4
RMSC175-1.00	10-24 3/16" tube	4.4	25.4	1.4
RMSC221-1.00	M6	5.6	25.4	1.5
RMSC223-1.50	M6	5.7	38.1	1.5
RMSC233-1.50	1/4-20 1/4" tube	5.9	38.1	1.4
RMSC295-1.50	M8 5/16-18 5/16" tube	7.5	38.1	1.4
RMSC355-1.50	3/8-16 3/8" tube	9.0	38.1	1.4
RMSC375-1.50	M10	9.5	38.1	1.4
RMSC415-1.50	7/16" tube/thread	10.5	38.1	1.4
RMSC456-1.50	M12	11.6	38.1	1.7
RMSC480-1.50	1/2" tube/thread	12.2	38.1	1.4
RMSC535-1.50	M14 9/16" tube/thread	13.6	38.1	1.4
RMSC600-1.50	M16 5/8" tube/thread	15.2	38.1	1.4
RMSC615-4.00	M16 5/8" tube/thread	15.6	101.6	1.5
RMSC730-1.50	M19 3/4" tube/thread	18.5	38.1	1.5
RMSC740-4.00	M19 3/4" tube/thread	18.8	101.6	1.4
RMSC855-1.50	M22 7/8" tube/thread	21.7	38.1	1.4
RMSC970-4.00	M25 1" tube/thread	24.6	101.6	1.4
RMSC980-1.50	M25 1" tube/thread	24.9	38.1	1.4
RMSC1.062-1.75	---	27.0	44.5	1.6
RMSC1.125-1.75	---	28.6	44.5	1.6
RMSC1.187-1.75	---	30.1	44.5	1.6
RMSC1.250-1.75	---	31.2	127.0	1.4
RMSC1.375-2.00	---	31.8	44.5	1.6
RMSC1.500-2.00	---	34.9	50.8	1.6
RMSC1.750-2.00	---	38.1	50.8	1.6
RMSC1.875-2.00	---	44.5	50.8	1.6
RMSC2.000-2.00	---	47.6	50.8	1.6



## MOCAP® Silicone Straight Caps

- Durable and Reusable Rubber Product
- Rubber Cap Sizes from 1.8mm to 47.6mm
- Micro-Pack and Mini-Pack Quantities Available





## SMSP Series Silicone Tapered Plugs

- Resists Temps to 302° C (575° F)
- Larger Sizes also Available with a Hollow End for Cost Savings - SMSHP Series
- Tapered Design Allows for Masking of Various Hole Diameters
- Material: Iron Oxide Orange Silicone



Part #	Suggested Applications	(A) Small Diameter	(B) Large Diameter	(C) Length
		mm	mm	mm
SMSP062/187	M3 5-40 8-32	1.6	4.7	19.1
SMSP125/250	M4 M5 10-24 12-48	3.2	6.4	25.4
SMSP187/343	M6 M7 M8 3/4 -20 7/16	4.7	8.7	25.4
SMSP250/437	M10 3/8 7/16	6.4	11.1	25.4
SMSP313/562	M12 M14 1/2 9/16	8.0	14.3	28.6
SMSP437/687	M16 5/8	11.1	17.4	25.4
SMSP562/750	M18 3/4	14.3	19.1	25.4
SMSP625/800	M20 7/8	15.9	20.3	25.4
SMSP750/925	M22 M24 1	19.1	23.5	25.4
SMSP827/1063*	---	21.0	27.0	28.3
SMSP1036/1246*	---	26.3	31.6	25.4
SMSP1187/1437*	---	30.1	36.5	25.4
SMSP1306/1622*	---	33.2	41.2	25.4
SMSP1469/1750*	---	37.3	44.5	25.4
SMSP1621/1973*	---	41.2	50.1	25.4
SMSP1881/2198*	---	47.8	55.1	25.4
SMSP2000/2469*	---	50.8	62.7	25.4
SMSP2118/2506*	---	53.8	63.7	25.4
SMSP2272/2697*	---	57.7	68.5	25.4
SMSP2437/2953*	---	61.9	75.0	34.9
SMSP2750/3500*	---	69.9	88.9	38.1
SMSP3250/4000*	---	82.6	101.6	38.1
SMSP3500/5000*	---	88.9	127.0	50.8

\* Also Available as Hollow Plugs; Please Specify SMSHP Prefix When Ordering.

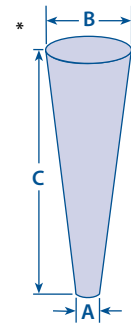

## SMSHP Series\* Hollow Silicone Plugs

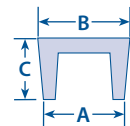

MOCAP's Hollow Silicone Plugs are a Lower Cost Option to Solid.

Maximum Temperature Specifications on page 66.

# MOCAP

## Silicone Tapered Plugs

- Durable and Reusable
- Sizes to Fit 3.2mm to 127mm holes
- Micro-Pack and Mini-Pack Quantities Available



For More Information, Please Contact Sales on  
**0800 856 2466**



# Masking



## SMPP Series Silicone Pull Plugs

- Resists Temps to 302°C (575°F)
- Convenient Handle and Parallel Design for Masking of Through-Holes
- Material: Iron Oxide Orange Silicone

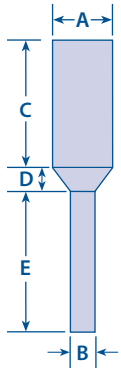
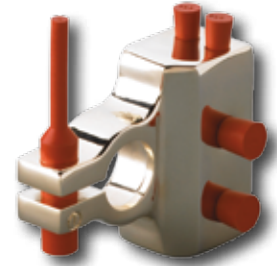

Part #	Suggested Applications	(A) Diameter mm	(B) Stem Diameter mm	(C) Length mm	(D) Bevel Length mm	(E) Stem Height mm
SMPP1.5/2.8	4-40	2.8	1.5	15.9	3.0	15.9
SMPP2.1/3.3	6-32	3.3	2.1	15.9	3.0	15.9
SMPP2.2/3.6	M4	3.6	2.2	15.9	2.0	14.0
SMPP2.1/4.0	8-32	4.0	2.1	15.9	3.0	15.9
SMPP2.8/4.6	10-24	4.6	2.8	15.9	3.0	15.9
SMPP3.2/5.5	M6	5.5	3.2	25.0	3.0	22.0
SMPP3.2/5.7	1/4-20	5.7	3.2	25.4	3.0	25.4
SMPP3.3/7.0	M8, 5/16-18	7.0	3.3	25.4	3.0	25.4
SMPP4.0/8.5	3/8-16	8.5	4.0	25.4	3.0	25.4
SMPP4.0/9.0	M10	9.0	4.0	25.0	3.0	22.0
SMPP4.0/11.3	1/2	11.3	4.0	25.4	5.0	25.4



## SMFP Series Silicone Washer Plugs

- Resists Temps to 302°C (600°F)
- Features a Flange for Masking the Area Around a Hole
- Material: Iron Oxide Orange Silicone

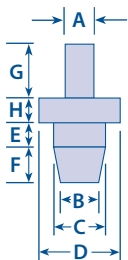

Part #	(A) Stem Diameter mm	(B) Plug Small Diameter mm	(C) Plug Large Diameter mm	(D) Flange O.D. mm	(E) Length mm	(F) Bevel Length mm	(G) Stem Height mm	(H) Flange Thickness mm
SMFP2.4E10.0R	4.0	1.5	2.4	10.0	2.5	4.0	15.0	3.0
SMFP3.6E12.0R	4.0	2.0	3.6	12.0	3.2	4.0	15.0	3.0
SMFP4.5E12.0R	4.0	2.8	4.5	12.0	3.5	5.5	15.0	3.0
SMFP5.5E13.0R	5.0	3.0	5.3	13.0	3.5	6.5	15.0	3.0
SMFP7.2E15.0R	5.0	4.0	7.2	15.0	4.0	8.0	15.0	3.0
SMFP8.8E20.0R	6.0	4.5	8.8	20.0	4.0	12.0	15.0	3.0
SMFP10.6E22.0R	6.0	5.5	10.6	22.0	4.0	14.0	15.0	3.0

## MOCAP Stocked Parts

We keep many varieties of our caps, plugs and grips in stock and ready to ship. All of our stock items are available in Box, Mini-Pack and Micro-Pack quantities and can be ordered online for faster turnaround.

[www.mocap.co.uk](http://www.mocap.co.uk)





## ST Series Silicone Rubber Tubing

- Stocked in 25m Lengths
- Resists Temperatures to 260°C (500°F)
- Material: Iron Oxide Orange Silicone



Part #	(A) Inside Diameter	(B) Wall Thickness	Roll Length
	mm	mm	meters
ST2.0E4R	2.0	1.0	25.0
ST2.8E4.8R	2.8	1.0	25.0
ST3.8E5.8R	3.8	1.0	25.0
ST4.8E6.8R	4.8	1.0	25.0
ST5.7E7.7R	5.7	1.0	25.0
ST7.5E10.5R	7.5	1.5	25.0
ST9.5E12.5R	9.5	1.5	25.0
ST11.0E14.0R	11.0	1.5	25.0
ST12.0E15.0R	12.0	1.5	25.0
ST14.0E17.0R	14.0	1.5	25.0
ST15.0E18.0R	15.0	1.5	25.0
ST16.0E19.0R	16.0	1.5	25.0
ST18.0E21.0R	18.0	1.5	25.0
ST19.0E22.0R	19.0	1.5	25.0
ST20.0E23.0R	20.0	1.5	25.0
ST22.0E25.0R	22.0	1.5	25.0
ST23.0E26.0R	23.0	1.5	25.0
ST25.0E28.0R	25.0	1.5	25.0

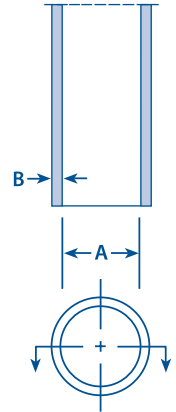

# MOCAP®

## Silicone Rubber Tubing

- Durable and Reusable Silicone Rubber Tubing
- Stocked in Diameters from 2mm to 25mm for Immediate Shipment

# Masking



## KMRC Series EPDM Straight Caps

- Resists Chemicals and Temps to 149°C (300°F)
- Flexible for Masking Threaded and Smooth Studs
- Material: Black EPDM Rubber

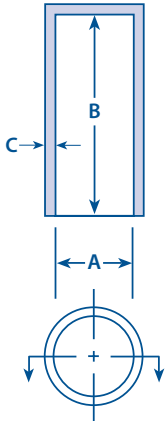

Part #	Suggested Applications	(A) Inside Diameter	(B) Inside Length	(C) Wall Thickness
		mm	mm	mm
KMRC070-1.00	M2 2-56	1.8	25.4	1.7
KMRC100-1.00	M3 4-40	2.5	25.4	1.3
KMRC120-1.00	6-32 1/8" tube	3	25.4	1.3
KMRC148-1.00	M4 8-32	3.8	25.4	1.4
KMRC175-1.00	10-24 3/16" tube	4.4	25.4	1.4
KMRC221-1.00	M6	5.6	25.4	1.5
KMRC223-1.50	M6	5.7	38.1	1.5
KMRC233-1.50	1/4-20 1/4" tube	5.9	38.1	1.4
KMRC295-1.50	M8 5/16-18 5/16" tube	7.5	38.1	1.4
KMRC355-1.50	3/8-16 3/8" tube	9	38.1	1.4
KMRC375-1.50	M10	9.5	38.1	1.4
KMRC415-1.50	7/16" tube/thread	10.5	38.1	1.4
KMRC456-1.50	M12	11.6	38.1	1.7
KMRC480-1.50	1/2" tube/thread	12.2	38.1	1.4
KMRC535-1.50	M14 9/16" tube/thread	13.6	38.1	1.4
KMRC600-1.50	M16 5/8" tube/thread	15.2	38.1	1.4
KMRC730-1.50	M19 3/4" tube/thread	18.5	38.1	1.5
KMRC740-4.00	M19 3/4" tube/thread	18.8	101.6	1.4
KMRC855-1.50	M22 7/8" tube/thread	21.7	38.1	1.4
KMRC970-4.00	M25 1" tube/thread	24.6	101.6	1.4
KMRC980-1.50	M25 1" tube/thread	24.9	38.1	1.4
KMRC1.062-1.75	---	27	44.5	1.6
KMRC1.125-1.75	---	28.6	44.5	1.6
KMRC1.187-1.75	---	30.1	44.5	1.6
KMRC1.250-1.75	---	31.8	44.5	1.6
KMRC1.375-2.00	---	34.9	50.8	1.6
KMRC1.500-2.00	---	38.1	50.8	1.6
KMRC1.750-2.00	---	44.5	50.8	1.6
KMRC1.875-2.00	---	47.6	50.8	1.6
KMRC2.000-2.00	---	50.8	50.8	1.6

# MOCAP®

## EPDM Straight Caps

- Durable and Reusable
- Flexible for Masking Threaded and Smooth Studs



For More Information, Please Contact Sales on  
**0800 856 2466**



## KMRP Series EPDM Tapered Plugs

- Resists Chemicals and Temps to 149°C (300°F)
- Tapered Design Allows for Masking of Various Hole Diameters
- Material: Black EPDM Rubber



Part #	Suggested Applications	(A) Small Diameter	(B) Large Diameter	(C) Length
		mm	mm	mm
KMRP062/187	M3 5-40 8-32	1.6	4.7	19.1
KMRP125/250	M4 M5 10-24 12-48	3.2	6.4	25.4
KMRP187/343	M6 M7 M8 3/4 -20 7/16	4.7	8.7	25.4
KMRP250/437	M10 3/8 7/16	6.4	11.1	25.4
KMRP313/562	M12 M14 1/2 9/16	8.0	14.3	28.6
KMRP437/687	M16 5/8	11.1	17.4	25.4
KMRP562/750	M18 3/4	14.3	19.1	25.4
KMRP625/800	M20 7/8	15.9	20.3	25.4
KMRP750/925	M22 M24 1	19.1	23.5	25.4
KMRP827/1063	---	21.0	27.0	28.3
KMRP1036/1246	---	26.3	31.6	25.4
KMRP1187/1437	---	30.1	36.5	25.4
KMRP1306/1622	---	33.2	41.2	25.4
KMRP1469/1750	---	37.3	44.5	25.4
KMRP1621/1973	---	41.2	50.1	25.4
KMRP1881/2198	---	47.8	55.1	25.4
KMRP2000/2469	---	50.8	62.7	25.4
KMRP2118/2506	---	53.8	63.7	25.4
KMRP2272/2697	---	57.7	68.5	25.4
KMRP2437/2953	---	61.9	75.0	34.9
KMRP2750/3500	---	69.9	88.9	38.1
KMRP3250/4000	---	82.6	101.6	38.1
KMRP3500/5000	---	88.9	127.0	50.8

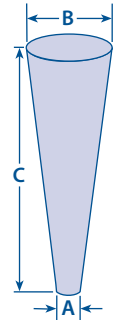

**Maximum Temperature Specifications on page 66.**

## MOCAP®

### EPDM Tapered Plugs

- Durable and Reusable
- Sizes to Fit 3.2mm to 127mm Holes
- Silicone Rubber Tapered Plugs Also Available

# Masking



## KMPP Series EPDM Pull Plugs

- Resists Chemicals and Temps to 149°C (300°F)
- Convenient Handle and Parallel Design for Masking of Through-Holes
- Material: Black EPDM Rubber

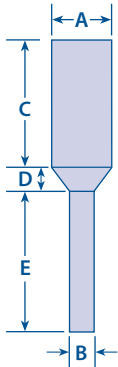

Part #	Suggested Applications	(A) Diameter mm	(B) Stem Diameter mm	(C) Length mm	(D) Bevel Length mm	(E) Stem Height mm
KMPP1.5/2.8	4-40	2.8	1.5	15.9	3.0	15.9
KMPP2.1/3.3	6-32	3.3	2.1	15.9	3.0	15.9
KMPP2.2/3.6	M4	3.6	2.2	15.9	2.0	14.0
KMPP2.1/4.0	8-32	4.0	2.1	15.9	3.0	15.9
KMPP2.8/4.6	10-24	4.6	2.8	15.9	3.0	15.9
KMPP3.2/5.5	M6	5.5	3.2	25.0	3.0	22.0
KMPP3.2/5.7	1/4-20	5.7	3.2	25.4	3.0	25.4
KMPP3.3/7.0	M8, 5/16-18	7.0	3.3	25.4	3.0	25.4
KMPP4.0/8.5	3/8-16	8.5	4.0	25.4	3.0	25.4
KMPP4.0/9.0	M10	9.0	4.0	25.0	3.0	22.0
KMPP4.0/11.3	1/2	11.3	4.0	25.4	5.0	25.4



## KMFP Series EPDM Washer Plugs

- Resists Chemicals and Temps to 149°C (300°F)
- Features a Flange for Masking the Area Around a Hole
- Material: Black EPDM Rubber



Part #	(A) Stem Diameter mm	(B) Plug Small Diameter mm	(C) Plug Large Diameter mm	(D) Flange O.D. mm	(E) Length mm	(F) Bevel Length mm	(G) Stem Height mm	(H) Flange Thickness mm
KMFP2.4R10.0B	4.0	1.5	2.4	10.0	2.5	4.0	15.0	3.0
KMFP3.6R12.0B	4.0	2.0	3.6	12.0	3.2	4.0	15.0	3.0
KMFP4.5R12.0B	4.0	2.8	4.5	12.0	3.5	5.5	15.0	3.0
KMFP5.5R13.0B	5.0	3.0	5.3	13.0	3.5	6.5	15.0	3.0
KMFP7.2R15.0B	5.0	4.0	7.2	15.0	4.0	8.0	15.0	3.0
KMFP8.8R20.0B	6.0	4.5	8.8	20.0	4.0	12.0	15.0	3.0
KMFP10.6R22.0B	6.0	5.5	10.6	22.0	4.0	14.0	15.0	3.0

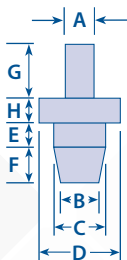

## MOCAP Stocked Parts

We keep many varieties of our caps, plugs and grips in stock and ready to ship. All of our stock items are available in Box, Mini-Pack and Micro-Pack quantities and can be ordered online for faster turnaround.

[www.mocap.co.uk](http://www.mocap.co.uk)





## X210L Series Polyester Tape

- Widths from 8mm to 450mm
- Withstands Up to 218°C (425°F) for 1 hour
- Adhesive Leaves No Residue After Removal
- Material: Green Polyester

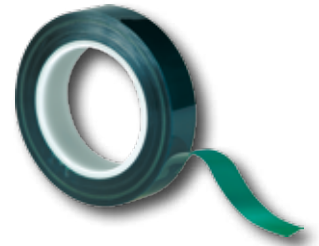

Part #	Tape Width		Roll Length	
		mm		meters
X210L10/33		10.0		33.0
X210L10/66		10.0		66.0
X210L15/66		15.0		66.0
X210L19/66		19.0		66.0
X210L20/33		20.0		33.0
X210L20/66		20.0		66.0
X210L25/33		25.0		33.0
X210L25/66		25.0		66.0
X210L30/66		30.0		66.0
X210L50/33		50.0		33.0
X210L50/66		50.0		66.0



## W210L Series Polyester Discs

- Diameters from 5mm to 76mm Please call for info on other sizes
- Withstands Up to 218°C (425°F) for 1 hour
- Split Backing Saves Labour Time
- Adhesive Leaves No Residue After Removal
- Material: Green Polyester

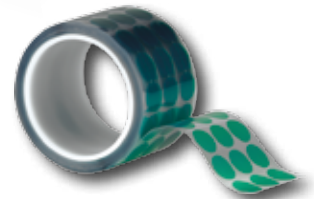

Part #	(A) Diameter		QTY Per Roll
		mm	
W210L5		5.0	5000
W210L6		6.0	5000
W210L8		8.0	5000
W210L10		10.0	5000
W210L11		11.0	5000
W210L12		12.0	2500
W210L14		14.0	2000
W210L15		15.0	2000
W210L16		16.0	2000
W210L19		19.0	2000
W210L20		20.0	2000
W210L22		22.0	2000

Part #	(A) Diameter		QTY Per Roll
		mm	
W210L25		25.0	2000
W210L28		28.0	1000
W210L30		30.0	1000
W210L32		32.0	1000
W210L38		38.0	1000
W210L40		40.0	1000
W210L44.4		44.5	1000
W210L50		50.0	500
W210L55		55.0	500
W210L60		60.0	500
W210L76		76.0	500

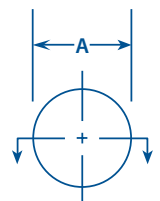

\* Split backing is only available on diameters of 10mm or greater.

### Custom Shapes Available

For More Information, Please Contact Sales on  
**0800 856 2466**

# Masking

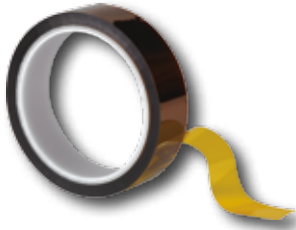

## X260K Series Polyimide Tape

- Widths from 8mm to 450mm
- Withstands Up to 260° C (500°F) for 1 hour
- Adhesive Leaves No Residue After Removal
- Material: Amber Polyimide

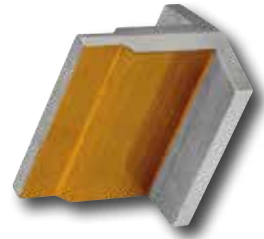

Part #	Tape Width		Roll Length	
	mm	meter	mm	meter
X260K10/33	10.0	33.0		
X260K12/33	12.0	33.0		
X260K15/33	15.0	33.0		
X260K19/33	19.0	33.0		
X260K20/33	20.0	33.0		
X260K25/33	25.0	33.0		
X260K30/33	30.0	33.0		
X260K50/33	50.0	33.0		



# MOCAP®

## Tapes & Masking Discs

All of our *Polyester Tapes*, *Polyimide Tapes* and *Masking Discs* are Easily Removed after Use.

Silicone Based Adhesive Leaves No Residue after Removal.

Unique *Split Backing* is Standard on Disc Rolls

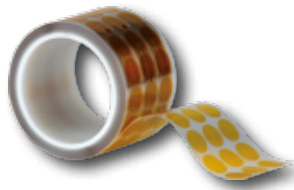

## W260K Series Polyimide Discs

- Diameters from 5mm to 76mm *Please call for info on other sizes*
- Withstands Up to 260° C (500°F) for 1 hour
- Split Backing Saves Labour Time
- Adhesive Leaves No Residue After Removal
- Material: Amber Polyimide

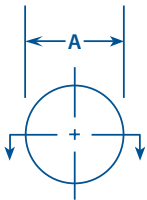

Part #	(A) Diameter		QTY Per Roll
	mm	mm	
W260K6.4/5000	6.4	5000	
W260K8/5000	8.0	5000	
W260K10/5000	10.0	5000	
W260K12/2500	12.0	2500	
W260K25/2000	25.0	2000	

\* Split backing is only available on diameters of 10mm or greater.

For More Information, Please Contact Sales on  
**0800 856 2466**



## MCN Series Plastic Netting for Superior Protection

- Open Design Prevents Corrosion
- Flexible to Fit Irregular Shapes
- Sold in Rolls, but can be Sliced to Length
- Material: Low-Density Polyethylene in Specific Colours Per Size

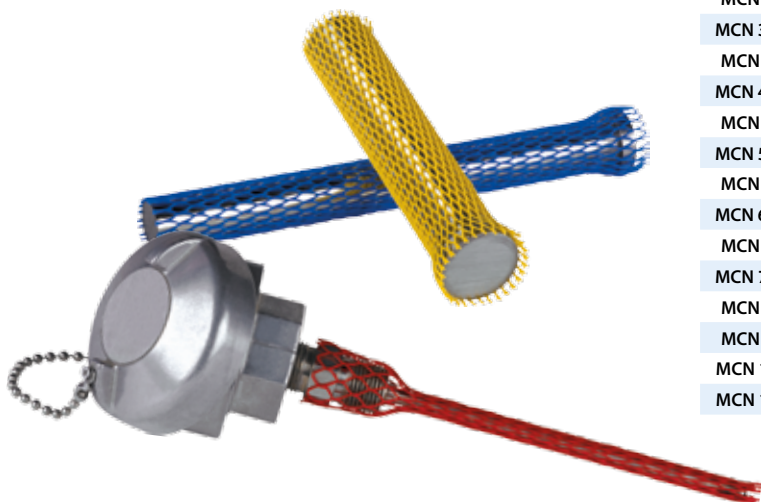
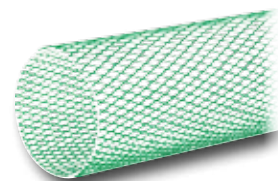

Part #	Colour	APPROXIMATE DIAMETER RANGE						LENGTH PER ROLL or BOX
		in		mm				m
MCN 3	RED	1/4	to 3/8	6.35	to 9.53			249.9
MCN 3A	RED	1/4	to 3/8	6.35	to 9.53			457.2
MCN 4	ORANGE	3/8	to 5/8	9.53	to 15.88			249.9
MCN 4A	ORANGE	3/8	to 5/8	9.53	to 15.88			457.2
MCN 5	BLUE	5/8	to 1	15.88	to 25.40			249.9
MCN 5A	BLUE	5/8	to 1	15.88	to 25.40			457.2
MCN 6	YELLOW	1	to 2	25.40	to 50.80			50.0
MCN 6A	YELLOW	1	to 2	25.40	to 50.80			457.2
MCN 7	RED	2	to 4	50.80	to 101.60			50.0
MCN 7A	RED	2	to 4	50.80	to 101.60			457.2
MCN 8	GREEN	4	to 6	101.60	to 152.40			50.0
MCN 9	BROWN	6	to 8	152.40	to 203.20			50.0
MCN 10	CRYSTAL	8	to 10	203.20	to 254.00			50.0
MCN 11	GREEN	10	to 12	254.00	to 304.80			50.0

## Secondary Operations

**Printing**

**Assembly**

**Punching & Slicing**

Customised to Fit Your Specifications

Standard Ink Colours



Additional Colours Available



For More Information, Please Contact Sales on  
**0800 856 2466**

# ClearTec® Packaging

A Division of **MOCAP**

Round  
Tubes

Sealed Bottom  
Tubes

Hanging  
Tubes



Packaging, Storage & Protection for:  
Posters • Apparel • Cutting Tools • Craft Beads • Gift Packs/Kits • Toys • Candy  
*and virtually anything else you can imagine*

[www.cleartecpackaging.co.uk](http://www.cleartecpackaging.co.uk)

0800 856 2466

[sales@mocap.co.uk](mailto:sales@mocap.co.uk)

**MOCAP**® PACKAGING SOLUTIONS

Telescopic  
Tubes

Insert  
Boxes

Multi Boxes  
& Set Paks

**BECKETT**<sup>®</sup>  
PACKAGING

A Division of **MOCAP**



Packaging, Storage & Protection for:  
Cutting Tools • Fasteners • Packaged Sets • DIY • Consumer Items  
*and many other applications*

[www.cleartecpackaging.co.uk](http://www.cleartecpackaging.co.uk)

0800 856 2466

[sales@mocap.co.uk](mailto:sales@mocap.co.uk)

**MOCAP**<sup>®</sup> PACKAGING SOLUTIONS

# Silicone **X-TREME TAPE**<sup>®</sup>

## Self-Fusing Silicone Rubber Tape



Lasts for  
Years



UV & Salt  
Resistant



260° C



-50° C

**3X**  
Stretch



Insulates  
15000 V/mm



No Glue



Moisture & Oil  
Resistant



- No Adhesive, Therefore No Residue When Removed
- Conforms to Shape to Create an Air and Water Tight Seal

- Resists Temps +500° F (260° C) to -60° F (-50° C)
- Available in 9 Colours

[uk.xtremetape.eu](http://uk.xtremetape.eu)

[sales@mocap.co.uk](mailto:sales@mocap.co.uk)

+0800 856 2466

	Material	General Description	Hardness (Shore A)	Tensile Strength (MNm-2)	Elongation (%)	Tear Strength (PPI)	Operating Temperature				Electrical Insulation
							Low °C	Low °F	High °C	High °F	
Dip Moulded Vinyl	9238	General Purpose Glossy	75	15	300	200	-30	-22	100	212	Good
	HT-201	Hi-Temp Resistant	80	16	250	250	-18	0	230	446	Good
	9400M	Medical Grade	62	13	350	150	-20	+4	60	140	---
	9100	Textured	60	12	350	100	-29	-20	66	150	---
Rubber	Silicone	Extra Temperature (EHTSi)	---	6	300	75	-76	-104	302	575	---
	EPDM	Hi-Temp Chemical Resistant	---	10	320	200	-55	-67	149	300	---
Resins	LDPE	Low Density Polyethylene	---	600-2300 PSI	---	---	-70	-94	79	175	---
	HDPE	High Density Polyethylene	---	3100-5500 PSI	---	---	-18	0	102	215	---
	PP	Polypropylene	---	4300-5500 PSI	---	---	-70	-94	121	250	---
	TPE	Thermoplastic Elastomer	82	580-1610 PSI	---	220	-60	-76	135	275	---
Paper	NYLON	Nylon PA6	---	10741 PSI	---	---	-40	-40	121	250	---
	Paper	Tan Recycled Paper	---	---	---	---	---	---	204	400	---

*Additional Formulas (Antistatic, Flame Retardant etc.), Compounds & Resins Available, Please Contact Sales for Further Information*

## Material Maximum Temperature Specifications

Material	9400M	9100	LDPE	9238	HDPE	PP • NYLON	TPE	EPDM	PAPER	HT201	SILICONE
Temp	60° C / 140° F	66° C / 150° F	79° C / 175° F	100° C / 212° F	102° C / 215° F	121° C / 250° F	135° C / 275° F	149° C / 300° F	204° C / 400° F	230° C / 446° F	302° C / 575° F

Temperatures shown are guidelines. Please request a **FREE** sample for your testing.

## COLOUR OPTIONS

9238 Formula Vinyl:



## Tolerances

### VINYL PRODUCTS

- Minimum Length = 4.8mm (3/16")
- Length is variable in 1.6mm (1/16") increments
- Inside length tolerance is +/- 1.6mm (1/16") • Length measured along inside wall, not from centre, with the exception of the F-Series.
- Wall thickness as noted, unless special request
- Wall tolerance +/- .010" .25mm (0.010")
- Wall measured approximately 6.4mm (1/4") from open end, with wall increasing slightly towards the closed end of cap
- Above tolerances refer to Standard Formulation 9238 or High-Temp HT201 (Additional formulations are available).

### POLY PRODUCTS

- Typical tolerance for part dimension:
  - 0.000"-3.000": ± 0.010" (0mm to 76.2mm : ± .25mm)
  - 3.001"-5.000": ± 0.015" (76.23mm to 127mm : ± .38mm)
  - 5.001" and up: ± 0.020" (127.1mm and up : ± .51mm)
- On SMR Series parts 1-1/16" and larger, the tolerance for dimension "A" is +0.018"/-0.010" (+0.45mm/- .25mm)

### RUBBER PRODUCTS

All Thermoset Rubber Products are manufactured to RMA® "A3" Commercial tolerances

For More Information, Please Contact Sales on

**0800 856 2466**

 **MOCAP**  
United Kingdom  
Hortonwood 35  
Telford, Shropshire TF1 7YW  
Great Britain  
Tel: +0800 856 2466  
Fax: +44 1952 670241  
www.mocap.co.uk  
sales@mocap.co.uk  
(Sales & Manufacturing Location)



Unit 9 Tinsley Industrial Park  
Shepcote Way  
Sheffield, South Yorkshire S9 1TH  
Tel: +44 1952 670247  
Fax: +44 1952 670241  
(Manufacturing Location)



 **MOCAP**  
France  
Tel: +33 182 88 58 31  
Fax: +33 176 75 33 34  
www.mocap-france.com  
info@mocap-france.com

 **MOCAP**  
Italy  
Tel: 800 986554  
Fax: 800 986556  
www.mocap.it  
info@mocap.it

 **MOCAP**  
Spain  
Tel: +34 868 48 01 13  
Fax: +34 868 48 01 14  
www.mocap.com.es  
ventas@mocap.com.es

 **MOCAP**  
Germany  
Tel: +49 231 4461693  
Fax: +49 231 4461694  
www.mocap-deutschland.de  
info@mocap-deutschland.de

 **MOCAP**  
Poland  
Tel: +48 22 397 15 80  
Fax: +48 22 397 17 89  
www.mocap.com.pl  
info@mocap.com.pl

 **MOCAP** 茂凯  
China  
3 Industry Avenue North  
Xiaolan Town • Zhongshan  
Guangdong, China 528415  
Tel: +86 760-22836188  
Fax: +86 760-22836177  
www.mocap.com.cn  
sales@mocap.com.cn  
(Sales & Manufacturing Location)



**World Headquarters:**

 **MOCAP**  
United States  
409 Parkway Drive  
Park Hills, MO 63601 • USA  
314.543.4000  
314.543.4111 (fax)  
(Sales & Manufacturing Location)  
www.mocap.com  
800.633.6775  
sales@mocap.com  
customerservice@mocap.com



FAST LINK to our Website

